

# CAVITAR

## Welding Camera C300

### Operating Manual



# Contents

<b>1</b>	<b>INTRODUCTION.....</b>	<b>1</b>
<b>2</b>	<b>SAFETY INFORMATION .....</b>	<b>2</b>
<b>3</b>	<b>PROPERTIES .....</b>	<b>5</b>
<b>4</b>	<b>INSTALLATION.....</b>	<b>11</b>
4.1	SOFTWARE INSTALLATION .....	11
4.2	HARDWARE INSTALLATION.....	15
<b>5</b>	<b>OPERATION .....</b>	<b>18</b>
5.1	BEFORE OPERATION .....	18
5.2	CAVITAR CAPTURE SOFTWARE .....	18
5.2.1	<i>Registration .....</i>	<i>19</i>
5.2.2	<i>Opening the camera.....</i>	<i>21</i>
5.2.3	<i>Overview of CAVITAR Capture.....</i>	<i>22</i>
5.2.4	<i>Camera settings .....</i>	<i>24</i>
5.2.5	<i>Image adjustment.....</i>	<i>25</i>
5.2.6	<i>Guidelines.....</i>	<i>27</i>
5.2.7	<i>Calibration.....</i>	<i>29</i>
5.2.8	<i>Recording settings .....</i>	<i>33</i>
5.2.9	<i>Recording images .....</i>	<i>34</i>
5.2.10	<i>Viewing and saving recorded images .....</i>	<i>34</i>
5.2.11	<i>Snapshot.....</i>	<i>36</i>
5.3	STARTING AND STOPPING LASER ILLUMINATION .....	36
5.4	AFTER OPERATION .....	37
5.5	TROUBLESHOOTING .....	37
<b>6</b>	<b>MAINTENANCE AND SERVICE INFORMATION .....</b>	<b>38</b>
<b>7</b>	<b>SUPPORT AND END OF LIFE .....</b>	<b>39</b>
<b>8</b>	<b>LIMITED WARRANTY .....</b>	<b>40</b>

Cavitar Welding Camera, model C300 (Cavitar product code A040)

Operating Manual, Revision 1.1.4

© 2021 Cavitar Ltd.

All rights reserved. All unauthorized copying strictly prohibited.

Cavitar® is a registered trademark of Cavitar Ltd.

---

# 1 Introduction

Thank you for choosing Cavitar Welding Camera model C300 (later: Welding Camera)!

Welding Camera is a Finnish quality product developed and manufactured by Cavitar Ltd. We hope that you will be satisfied with your product.

Welding Camera is a highly compact and easy-to-use visualization system for the online monitoring of various welding processes, including MIG, MAG and TIG processes.

Welding Camera contains several unique features in order to enable highest possible image quality. These features include, among other things, extremely powerful spectral filtering combined with wavelength-stabilized laser output.

Standard Welding Camera has a fixed working distance (specified upon order), but adjustable working distance (adjustment range 150 mm ... 300 mm) is available as an option.

The laser source of the system doesn't require any control by the operator. Therefore, from the operation point of view, the system doesn't differ from a normal machine vision camera system. Welding Camera is a class 3R laser product with a nominal ocular hazard distance (NOHD) of 3 meters.

Please read this operating manual carefully before using Welding Camera.

Chapter 2 contains important safety information for the safe operation of Welding Camera.

Chapter 3 describes the properties of Welding Camera and Chapter 4 deals with the installation of the system.

Chapter 5 describes the operation of Welding Camera.

Chapters 6 to 8 cover issues related to maintenance, service, support and warranty.

The actual appearance of software or components may vary.

The symbols below are applied throughout this operating manual:

**NOTE!** indicates useful tips for easier operation

**CAUTION!** indicates potential risk of serious damage to the device

**WARNING!** indicates potential risk of serious injury to the user



## 2 Safety information

PLEASE CAREFULLY READ AND UNDERSTAND THE FOLLOWING SAFETY INSTRUCTIONS BEFORE USING WELDING CAMERA. IT IS OF UTMOST IMPORTANCE TO STRICTLY OBEY THESE INSTRUCTIONS. OTHERWISE SERIOUS DAMAGE TO THE USER OR TO THE DEVICE MAY OCCUR.

ONLY A PERSON, WHO HAS CAREFULLY READ AND UNDERSTOOD ALL SAFETY INSTRUCTIONS BELOW AND THE REST OF THIS OPERATING MANUAL, IS QUALIFIED FOR USING WELDING CAMERA. CAVITAR LTD. IS NOT LIABLE FOR ANY DAMAGE CAUSED BY THE IMPROPER USE OF WELDING CAMERA.

CAUTION--USE OF CONTROLS OR ADJUSTMENTS OR PERFORMANCE OF PROCEDURES OTHER THAN THOSE SPECIFIED HEREIN MAY RESULT IN HAZARDOUS RADIATION EXPOSURE.

CAUTION--USE OF OPTICAL INSTRUMENTS WITH THIS PRODUCT WILL INCREASE EYE HAZARD.

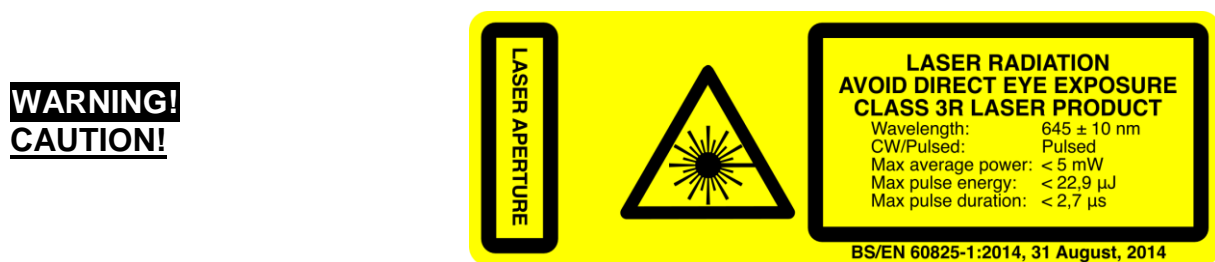

- Welding Camera is a class 3R laser system
  - laser class is indicated by the warning label on top of the camera unit (see the label above)
  - laser aperture is indicated by the yellow aperture label on top of the camera unit (see the label above)
  - Nominal Ocular Hazard Distance (NOHD) is 3 meters
- Do not look into the direct, reflected or scattered laser beam
  - camera unit emits visible red laser light at  $645 \pm 10$  nm wavelength band
  - laser beam is emitted from the front of the camera unit (from the mirror-like window in Fig. 3.3). The beam spreads in such a way that it covers the field-of-view of the camera (~30 mm x 40 mm) at the design working distance (200 mm)
  - use of appropriate laser safety goggles is recommended for eye-safe operation. Suitable laser safety goggles must have an optical density of at least 3 (OD3) at the wavelength band  $645 \pm 10$  nm
- The accidental exposure to direct/reflected/scattered laser beam has to be prevented:
  - train personnel not to stare at the laser output
  - pay special attention to possible bystanders or persons passing by



- Other instructions:
  - Welding Camera is not certified for medical use
  - Do not make ANY modifications to the device by yourself
  - Do not try to repair the device by yourself
  - It is strictly forbidden to open the cover of the camera unit. Otherwise serious damage or injury to the user or to the device may occur. Camera unit contains gallium arsenide, which is a known human carcinogen
  - Before powering the system, ensure all connections are made according to this manual and all cables are intact. Broken cables can create a risk of electric shock which can cause serious damage or injury to the user or to the device
  - Welding Camera is intended for indoor use only
  - Do not expose the system to moisture, rain or condensing environment as this can create a risk of electric shock. Electric shock can cause serious damage or injury to the user or to the device
  - Do not expose the system (especially the signal inputs) to electrical shock or static discharge as this can create a risk of unintended laser emission, resulting in eye hazard
  - Excessive vibration or strong mechanical impact may damage the equipment.
  - The operating temperature of Welding Camera is +10...+40 °C with proper mounting. Do not expose the device to excessively low or high temperatures without appropriate means for controlling the temperature of the device
  - People prone to epileptic seizures are not allowed to operate the system nor be exposed to the laser emission (blinking frequency 100 Hz or less)
  - If you are uncertain about any issue related to safety or proper operating conditions, please contact your vendor or Cavitar
  - It is not allowed to dispose Welding Camera as unsorted municipal waste. The system must be returned to your vendor or to Cavitar for proper disposal at the end of their life. Alternatively one can consult local, state and federal regulations for proper disposal. Welding camera contains Gallium Arsenide. Gallium Arsenide is toxic and must not be released to the environment



---

## CERTIFICATIONS AND COMPLIANCE

- Cavitar Ltd. is an ISO 9001:2015 certified company
- CE declaration of conformity
  - Welding Camera, if installed and operated in accordance with the manufacturer's instructions, is in conformity with the following European, harmonized and published directives and standards:
    - 2011/65/EU (RoHS 2)
    - 2014/30/EU (Electromagnetic Compatibility)
    - 2014/35/EU (Low Voltage Directive)
    - BS/EN 60825-1:2014 (Laser Safety)
- Declaration of conformity with 21 CFR 1040.10 and 1040.11
  - Complies with 21 CFR 1040.10 and 1041.11 except for conformance with IEC 60825-1 Ed. 3., as described in Laser Notice No. 56, dated May 8, 2019.
- Safety
  - Welding Camera meets the requirements of the following electrical equipment safety standards:
    - IEC 61010-1:2010 + Am1:2016
    - EN 61010-1:2010
    - UL 61010-1: 3rd Edition
    - CSA C22.2 No. 61010-1-12
- Electromagnetic compatibility (EMC)
  - Welding Camera meets the requirements of the following EMC standards:
    - IEC 61326-1:2020: Immunity in an industrial electromagnetic environment
    - CISPR 11:2015/AMD2:2019: Group 1, Class A emissions
    - FCC 47 CFR Part 15B: Class A emissions
    - ICES-003 Issue 6: Class A emissions

Group 1 equipment is any industrial, scientific, or medical equipment that does not intentionally generate radio frequency energy in the frequency range 9 kHz to 400 GHz for the treatment of material or inspection/analysis purposes.

Class A equipment is suitable for use in all establishments other than domestic and those directly connected to a low voltage power supply network which supplies buildings used for domestic purposes.

Warning: Class A equipment is intended for use in an industrial environment. There may be potential difficulties in ensuring electromagnetic compatibility in other environments, due to conducted as well as radiated disturbances. This device complies with part 15 of the FCC Rules. Operation is subject to the following two conditions: (1) This device may not cause harmful interference, and (2) this device must accept any interference received, including interference that may cause undesired operation.



---

## 3 Properties

Welding Camera C300 system typically consists of the following components:

### **CAMERA UNIT**

- laser aperture label
- laser class 3R warning label
- easy-to-replace protective window
- mounting threads
- integrated channels for air or liquid cooling

### **POWER SUPPLY**

- power supply DC 24 V, 25 VA, including 1,2 m long fixed cable

### **CABLES**

- GigE cable (between camera unit and computer), standard length 10 m
- power cable (between camera unit and power supply), standard length 10 m
- power supply cable (between power supply and AC mains), standard length 2 m

### **ACCESSORIES**

- 2x spare protective window
- 2x cooling hose connector with O-ring
- 2x thermally conductive sheet (to be used between camera and mounting)

### **INSTALLATION CD**

- CAVITAR Capture software for controlling Welding Camera
- Operating manual
- Additional instructions:
  - Guide for working distance adjustment
  - Guide for external control via COM-port



**Table 3.1. Welding Camera C300 specifications.**

<b>Camera related</b>	
Default working distance	200 mm (good image quality within $\pm 15$ mm)
Field of view (@ default working distance)	approx. 40 mm x 30 mm
Max resolution	1440 pxl x 1080 pxl
Max frame rate (@ full resolution)	Typically 70-75 fps (computer dependent)
Max frame rate (with laser illumination)	100 fps
<b>Optical</b>	
Wavelength	645 $\pm$ 10 nm
CW/Pulsed	Pulsed
Max average power	< 5 mW
Max pulse energy	< 22,9 $\mu$ J
Max pulse duration	< 2,7 $\mu$ s
Laser class (according to BS/EN 60825-1:2014)	3R
Nominal ocular hazard distance (NOHD)	3 m
<b>Electrical</b>	
Power supply input voltage	AC 100-240 V, 47-63 Hz
Power supply output voltage	DC 24 V
Power supply power rating	25 VA
<b>Mechanical</b>	
Camera unit dimensions (W x H x L)	30 mm x 45 mm x 99 mm (excl. connectors)
Camera unit weight	~ 300 g
Camera unit attachment	4 x M4 and 6x M3 mounting threads
<b>Environmental</b>	
Storage temperature	0...+50 $^{\circ}$ C
Operation temperature	+10...+40 $^{\circ}$ C <sup>(1)</sup>
Indoor/outdoor use	Indoor use only
Humidity	max 80 % RH non-condensing
Altitude	max 2000 m above sea level
Pollution degree	PD2
Supply voltage fluctuations	$\pm$ 10 %
Overvoltage category	II
Pressure in integrated cooling circuitry	max 4 bar
Cooling liquid	mixture of pure water and inhibited glycol <sup>(2)</sup>
Inner diameter of the cooling hose	6 mm



- 
- (1) The camera heats up during operation. Please follow these guidelines to ensure proper cooling:
- a. Heat dissipation measures are needed if the camera temperature (displayed in CAVITAR Capture software) exceeds 55 °C. A warning message is displayed in CAVITAR Capture if the camera temperature reaches 57 °C. The maximum camera temperature is 65 °C and CAVITAR Capture stops image acquisition if this temperature is reached. If the camera temperature reaches 75 °C, an emergency shutdown will be initiated. Warranty doesn't cover damage caused by overheating due to inadequate cooling of the camera
  - b. The camera must be mounted/clamped in such a way that heat can be removed from the camera housing as efficiently as possible. In many cases it is possible to use a metallic (e.g. aluminium) mounting plate/arm with a good thermal contact to a larger heat sink such as metallic body of machinery
  - c. For optimal heat transfer, the mounting/clamping should cover as large portion of the camera side(s) as possible (good thermal contact to both camera sides is the most efficient cooling configuration)
  - d. It is strongly recommended to apply a thin thermally conductive sheet between the camera side(s) and the mounting as well as between mounting and larger heat sink to maximize heat transfer
  - e. If the mounting doesn't enable efficient heat transfer from the camera to a larger heat sink and if the ambient temperature doesn't exceed ~35 °C, separate heat sinks mounted to camera sides can be applied (Cavitar offers dedicated heat sinks as optional items)
  - f. Air or liquid cooling is needed in high ambient temperature environments
    - i. Never cool the camera to temperatures below dew point in order to prevent condensation (warranty doesn't cover damage caused by condensation). 20 °C is usually a safe temperature for the coolant to enter the camera
    - ii. Ensure continuous and sufficient flow of the coolant (a clear warning is needed if the flow is reduced/stopped in order to avoid damage to the camera)
    - iii. Carefully insulate the camera and the cables from the environment e.g. with appropriate thermally insulating protective sleeves. Also place the cooling hoses inside the same protective sleeve as this will keep the other cables cooler and also reduce the required cooling power
    - iv. Vortex pipes enable efficient air cooling. However, with vortex pipes special care must be taken not to cool the camera to temperatures below dew point
- (2) The camera contains integrated cooling channels for liquid cooling. Please follow these guidelines to ensure appropriate liquid cooling:
- a. Cooling channels inside the camera are made of aluminium. Only use cooling liquids and cooling equipment that are compatible with aluminium
  - b. Always ensure that the cooling connectors are properly fastened and free from any leaks. Leaking cooling liquid can get in contact with the back of the camera and may enter the camera, thus breaking the camera. Such damages are not covered by warranty
  - c. A mixture of pure water and inhibited glycol is recommended to avoid corrosion and algae growth
    - i. Pure water can be distilled, demineralised, de-ionised or reverse osmosis water
      1. Never use pure water without inhibited glycol since this causes corrosion
    - ii. Glycol must be inhibited (to avoid corrosion) and the glycol content in the mixture must be at least 20 volume % (to prevent algae growth)
      1. Ethylene glycol has better cooling performance than propylene-based glycol but is more toxic
      2. Modern industrial glycols contain inhibitors alongside a pH buffer and biocide to prevent corrosion, algae growth and rust
      3. Never mix different glycols
  - d. The cooling system must be properly flushed and cleaned before adding suitable inhibited glycol and pure water mixture as well as when the mixture needs to be changed
  - e. Prevent any contamination of the cooling liquid and cooling circuitry
  - f. A chiller with temperature and flow rate monitoring and alarm feature is recommended
  - g. Regular maintenance intervals are needed to ensure proper operation (e.g. checking the condition of filters and cooling liquid)
  - h. Never use automotive antifreeze liquids





Fig. 3.1. Camera unit (top view, fixed working distance version).

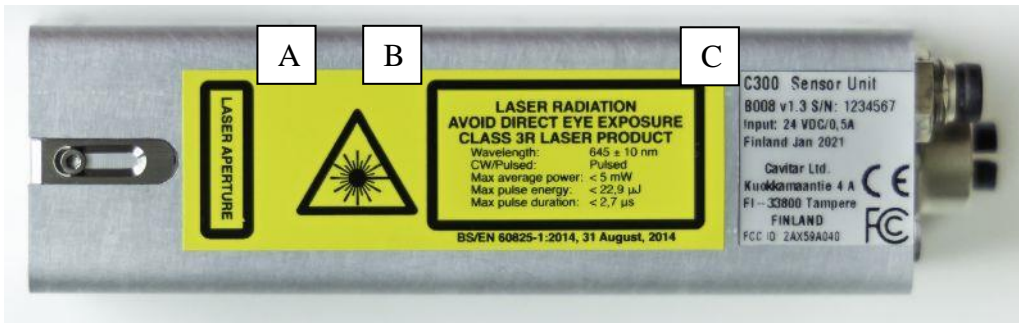

Fig. 3.2. Camera unit (top view, adjustable working distance version).



Fig. 3.3. Camera unit (front view).

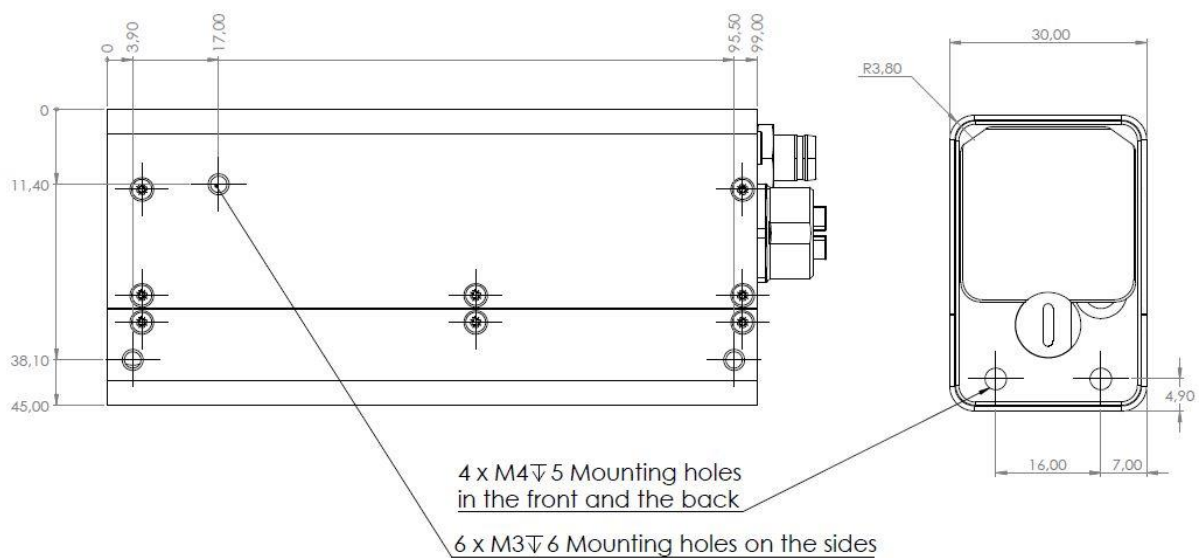

Fig. 3.4. Camera unit (back view).



In Figs. 3.1-3.4:

- A Laser aperture label
- B Laser warning label (laser hazard symbol and explanatory label)
- C Camera unit device label
- D Working distance adjustment (optional feature, for more details see the separate document “Working distance adjustment instructions”)
- E Protective window holder (rotate to change the replaceable protective window)
- F Mounting threads (2x M4, see Fig. 3.5 for more details)
- G Power led
- H Connector for power cable
- I Connector for GigE cable
- J Threads (2x M6x0.75) for air or liquid cooling
- K Chassis ground (2x M4 mounting threads)



**Fig. 3.5. Camera unit mechanical drawing.**



**Fig. 3.6. Bottom view of the power supply.**



---

**CAUTION!**

- Do not connect other than the supplied power supply to the camera unit.
- Only connect the power supply to a wall socket with protective grounding.
- Power supply can be disconnected from the mains supply by removing the power supply plug from the wall socket.



## 4 Installation

### 4.1 Software installation

Recommended computer properties are listed in Table 4.1:

**Table 4.1. Recommended computer properties.**

Operating system	Windows 10
Processor	Intel i5 or higher, preferably latest generation multicore processor
RAM memory	8 GB or more (depending on the recording requirements)
Hard disk	SSD with sufficient capacity (depending on the recording requirements)
Display	High quality display with wide viewing angle
GigE	At least two connectors, if two cameras are to be connected to the same computer
Cooling	Efficient cooling (e.g. ventilation or conductive cooling) to prevent heating

If applicable, please uninstall old software version completely before installing new software version!

Insert the CAVITAR Capture software CD into the CD drive and run the setup file (if the setup doesn't start automatically).

In some cases it may be necessary to disable firewall and/or virus software. As an example, in Windows 10 the "Check apps and files" feature under Windows Security App & Browser Control may need to be turned off. Please consult your IT support if needed.

The screenshots below show a typical installation procedure for Windows 10. The actual appearance of the windows may vary.



**Fig. 4.1. Select language and click "OK".**



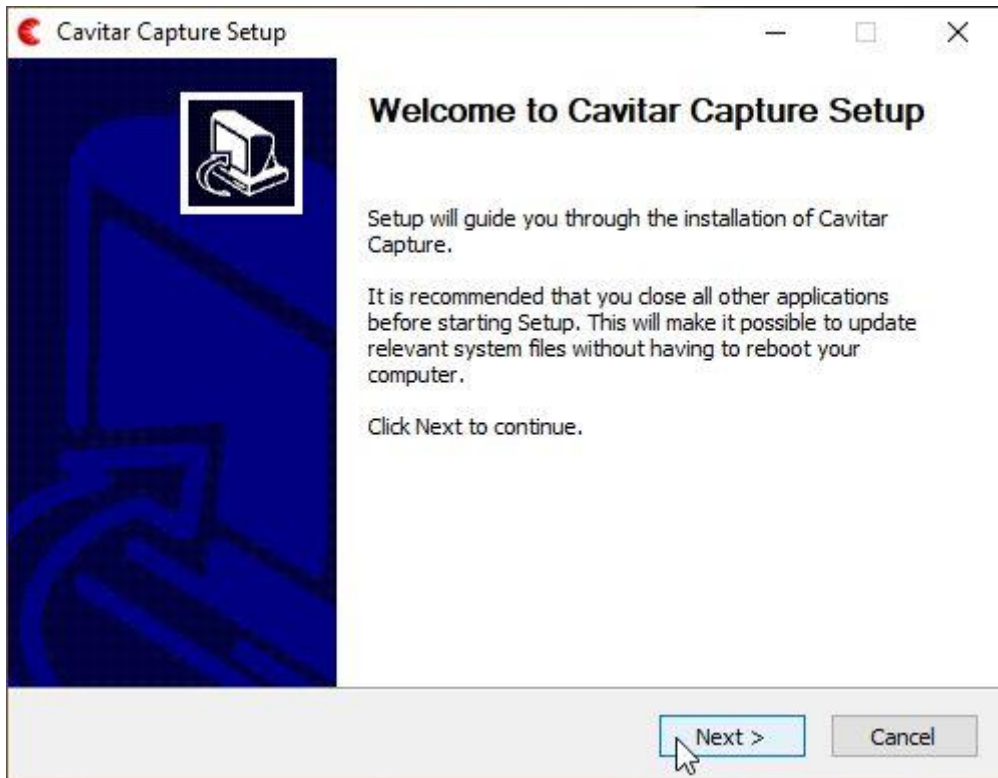

Fig. 4.2. close all other applications and click “Next” to start installation.

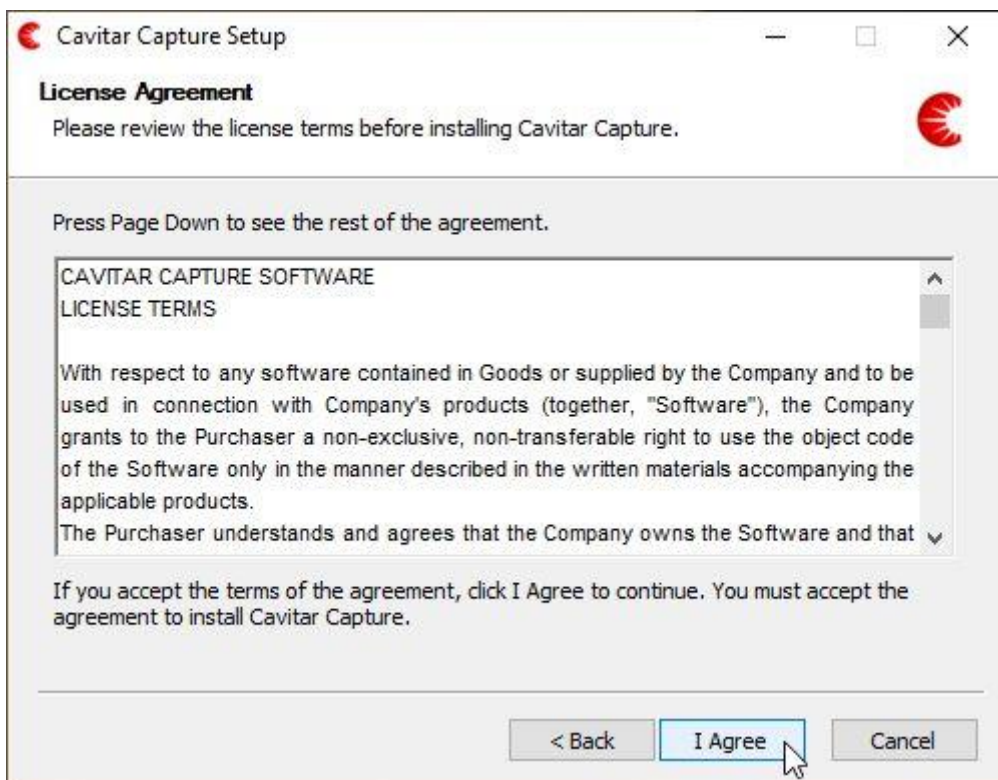
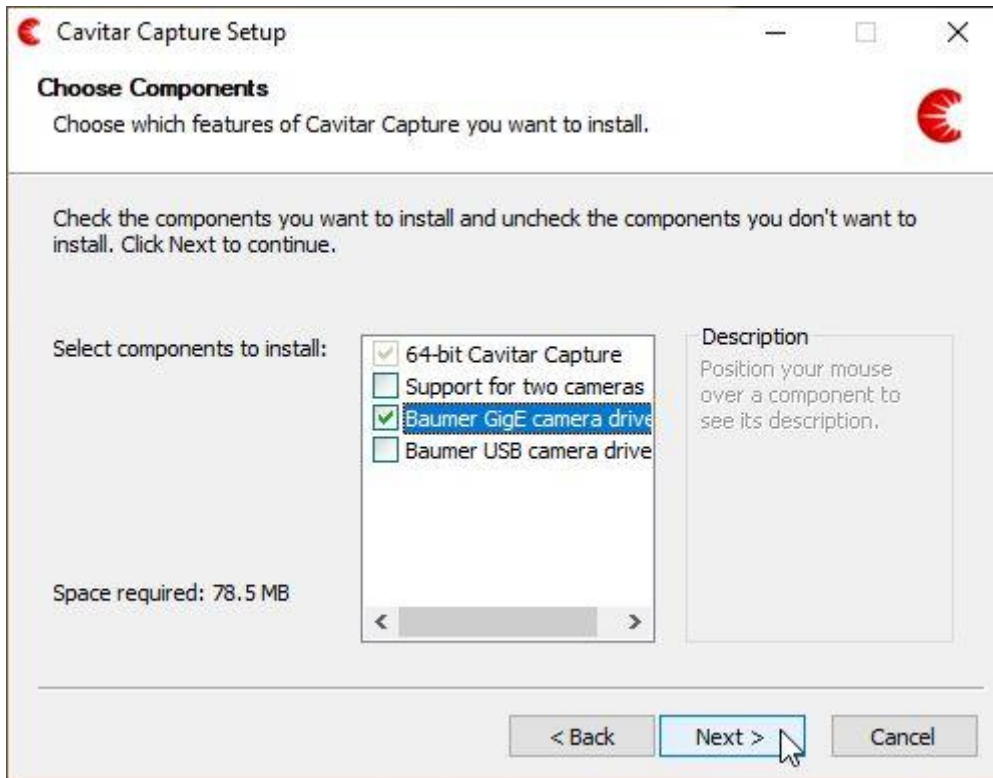
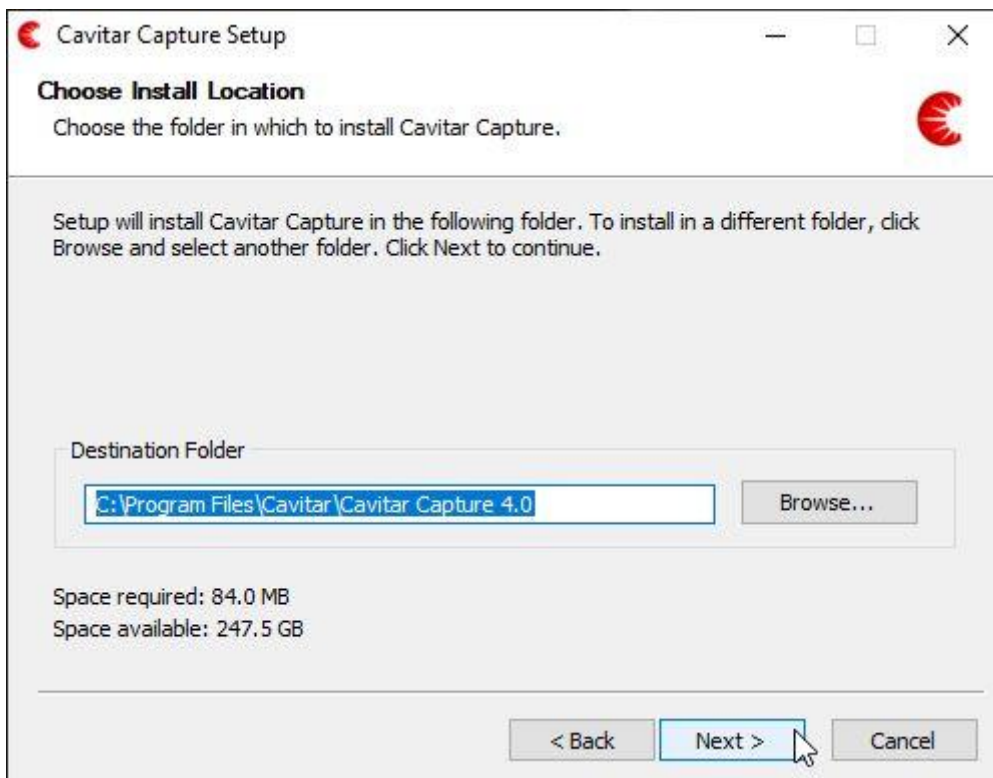

Fig. 4.3. Click “I Agree” to continue.



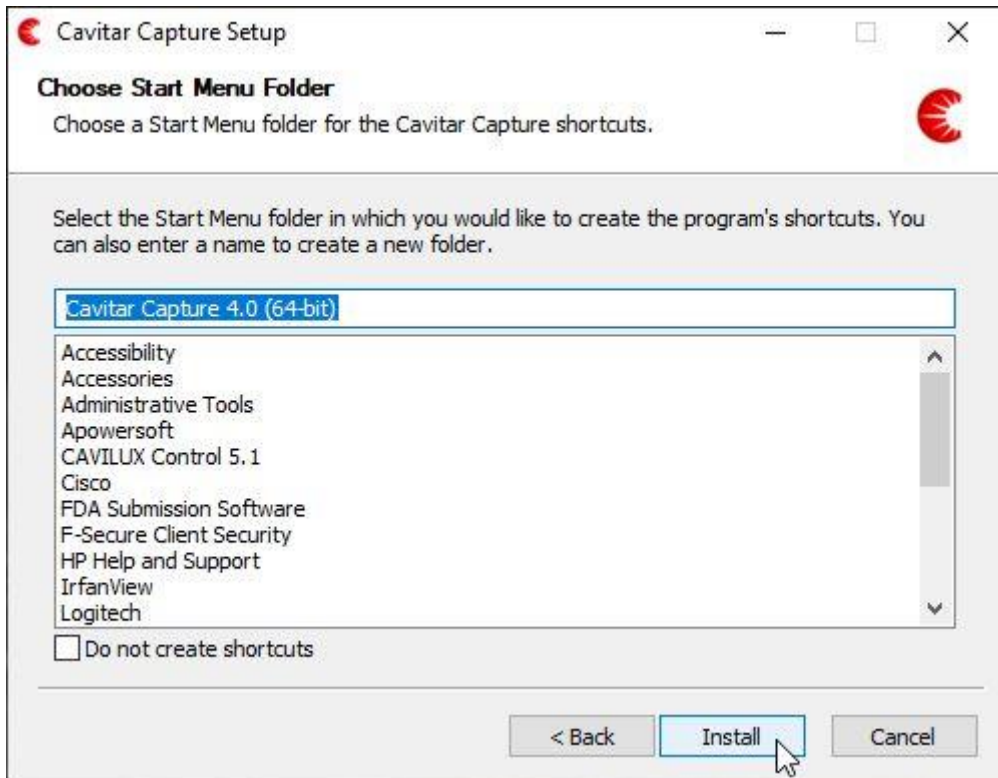

**Fig. 4.4.** Select “Support for two cameras” if two systems will be used with the same computer. Welding Camera has GigE interface, so USB camera drivers are usually not needed. Click “Next” to continue.

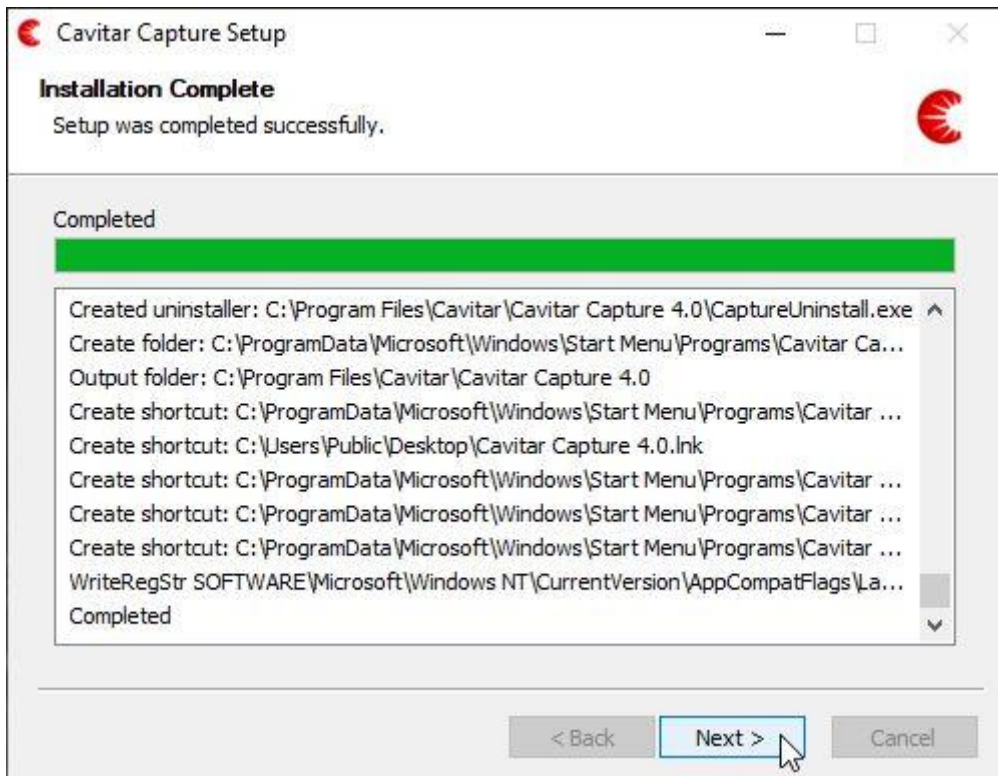

**Fig. 4.5.** Choose install location and click “Next” to continue.





**Fig. 4.6. Choose start menu folder and click “Install” to continue.**



**Fig. 4.7. After installation is completed, click “Next” to continue.**



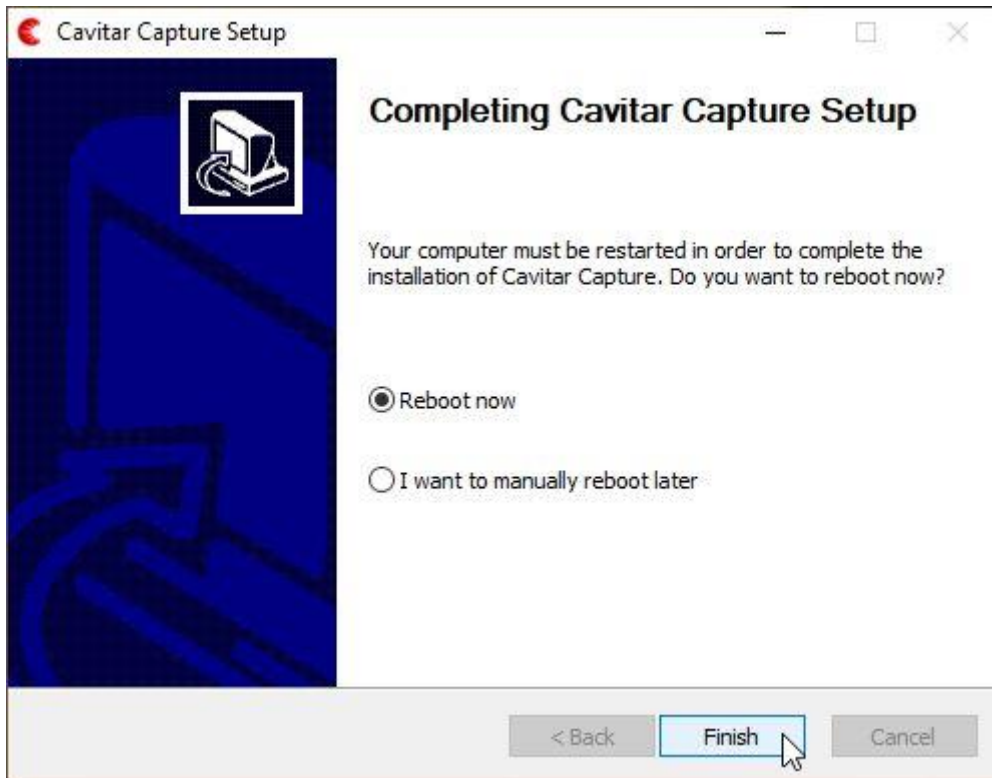

Fig. 4.8. Select “Reboot now” and click “Finish”.

## 4.2 Hardware installation

### Installation of camera unit

The camera unit should be mounted or clamped with an appropriate fixture in such a way that the object is located at the working distance of the camera unit. **The mounting must enable as efficient conductive** (low ambient temperature or heat load from process) **or active** (high ambient temperature or heat load from process) **cooling of the camera unit as possible.**

In case of conductive cooling, it is important to apply thermally conductive sheets between the camera side(s) and the mounting as well as between the mounting and larger heat sink (such as the body of machinery). Two thermally conductive sheets are provided together with the system for this purpose. **It is necessary to remove the transparent protective foil from the light blue thermally conductive sheet as the protective foil is thermal insulator!** It is also beneficial to maximize the area between camera side(s) and mounting. The mounting should be made of material with high thermal conductivity (such as aluminium).

If active cooling is applied, connect the cooling connectors (see Fig. 4.9G) to the threads of the camera unit (see Fig. 3.4J, ensure the O-rings are in place; maximum torque 1 Nm) and attach appropriate cooling system (air or liquid) to the connectors (suitable for hoses with inner diameter of 6 mm). **Always ensure that the cooling connectors and cooling hoses are properly fastened and free from any leaks.** Leaking cooling liquid can get in contact with the back of the camera and may enter the camera, thus breaking the camera. **Only use cooling liquids and cooling equipment that can be in contact with aluminium** (electro-chemical corrosion must be prevented). **The coolant must be sufficiently warm** (e.g. 20 °C) **to avoid problems related to condensation.** For more details, see Table 3.1 and the notes related to it.



**In order to minimize the effects of external electromagnetic fields, connect the chassis of the camera to ground via the grounding threads (see Fig. 3.4K) or via an appropriate mounting plate or heat sink.**

The camera unit must be properly protected from excessive radiation, heat/cold, condensation, vibration or mechanical forces (see Table 3.1 for more detailed specifications). If you feel uncertain about the correctness of the installation and/or about the suitability of the environment, please contact your vendor or Cavitar. Warranty does not cover damage caused by improper installation.

### **Electrical connections**

The electrical connections shall be made in the following way:

- connect the power cable (see Fig. 4.9A) between camera unit (see Fig. 3.4H) and power supply unit (see Fig. 4.9B)
- connect the power supply cable (see Fig. 4.9C) to the power supply
- connect the GigE cable (see Fig. 4.9D) between camera unit (see Fig. 3.4I) and computer (computer is not included in the standard system)
- ensure the camera unit housing is firmly connected to ground (see Fig. 3.4K)

Fig. 4.9 shows the welding camera system after the connections have been made. Also installation CD (Fig. 4.9E), spare protective windows (Fig. 4.9F), cooling connectors for air or liquid cooling (Fig. 4.9G) and thermally conductive sheets (Fig. 4.9H) are shown.

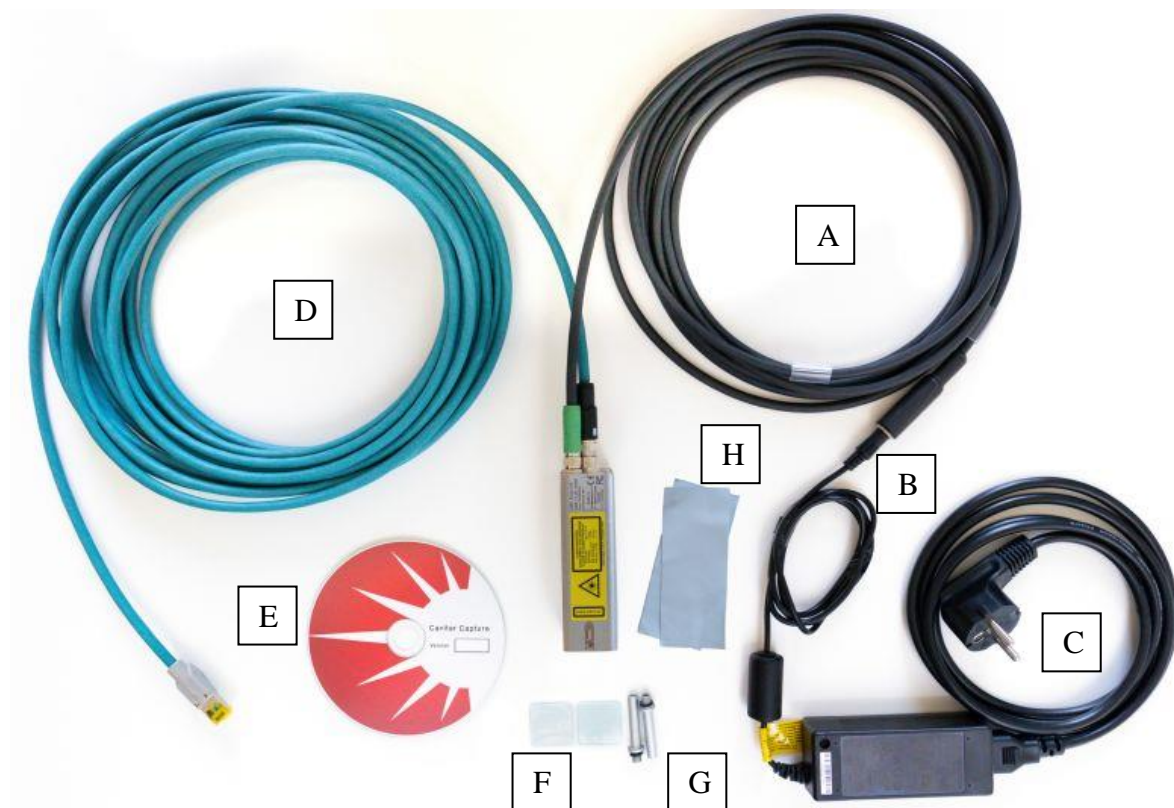

**Fig. 4.9. Welding Camera system after the connections have been made.**



---

**WARNING!**

- Ensure that the locations of all operation and adjustment controls as well as other system components are such that neither the operator nor anybody else can be accidentally exposed to laser radiation. Pay special attention to the placement of camera unit and computer.
- Ensure that all system components are placed in such a way that the applicable mains plugs are always easily removable from the electrical network.



---

## 5 Operation

After proper installation Welding Camera is ready for operation. In the following the operation of the system is described in more detail.

### 5.1 Before operation

Before operation the following preliminary issues need to be performed:

- check that camera unit is properly installed
- check that the replaceable protective window of the camera unit is clean
- power up the computer
- check that the electrical connections are as described in Section 4.2.
- make sure that the safety instructions (Chapter 2) have been properly followed
- connect the power supply cable to AC mains. This will power up the system. Green led in the camera unit will switch on

### 5.2 CAVITAR Capture software

Welding Camera is operated with CAVITAR Capture software. Before launching CAVITAR Capture, ensure that possible firewall or virus protection programs do not prevent the use of CAVITAR Capture (Welding Camera contains a GigE camera with a GigE interface).

In some cases the following actions may be needed:

- disconnect any network connections the computer may have. Also wireless networks should be disabled if firewall and virus protection settings need to be relaxed
- adjust firewall and virus protection settings in such a way that all network traffic is allowed
- connect the GigE cable to your computer after which the computer starts searching for the camera (this may take some time, depending on the computer). Typical announcements in Windows taskbar are “Identifying...No network access” (before connection to the camera is established) and “Unidentified network, No network access” (after connection to the camera is established).
- after the camera is found, CAVITAR Capture can be started

#### **CAUTION!**

- If firewall and virus protection settings need to be relaxed in order to enable the operation of the system, the settings must be restored to the normal settings before connecting the computer back to external network.



## 5.2.1 Registration

When starting CAVITAR Capture for the first time, registration procedure will start (see Figs. 5.1 – 5.5). Proceed by following the instructions and email the registration file to your vendor or Cavitar.

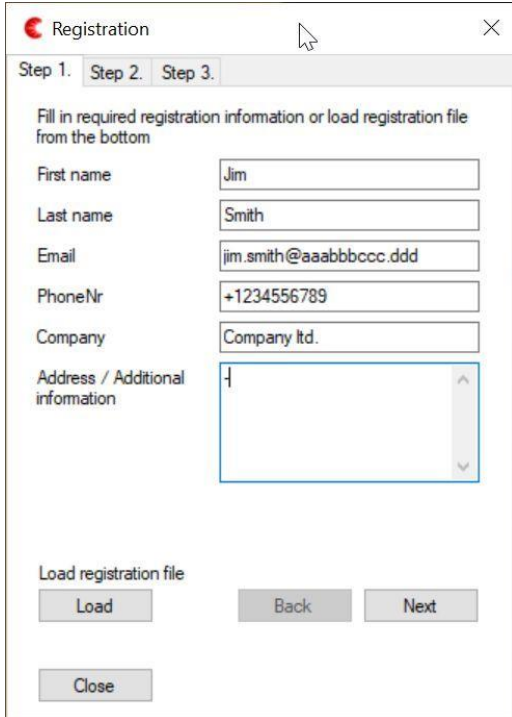

The dialog box is titled "Registration" and has three tabs: "Step 1.", "Step 2.", and "Step 3.". The "Step 1." tab is active. The text reads: "Fill in required registration information or load registration file from the bottom". Below this are several input fields: "First name" (Jim), "Last name" (Smith), "Email" (jim.smith@aaabbbccc.ddd), "PhoneNr" (+1234556789), and "Company" (Company ltd.). There is also a text area for "Address / Additional information" with a vertical scrollbar. At the bottom, there is a "Load registration file" section with a "Load" button, and "Back" and "Next" buttons. A "Close" button is at the very bottom.

Fig. 5.1. Registration: step 1.

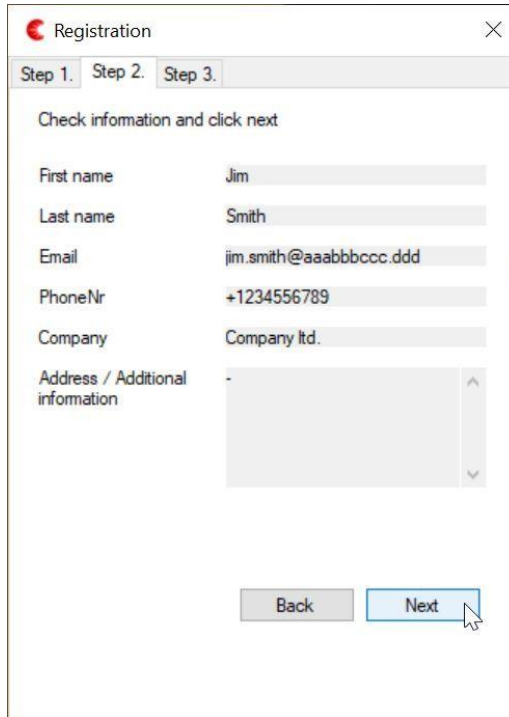

The dialog box is titled "Registration" and has three tabs: "Step 1.", "Step 2.", and "Step 3.". The "Step 2." tab is active. The text reads: "Check information and click next". The input fields from Step 1 are now disabled and filled with the same data: "First name" (Jim), "Last name" (Smith), "Email" (jim.smith@aaabbbccc.ddd), "PhoneNr" (+1234556789), and "Company" (Company ltd.). The "Address / Additional information" text area is also disabled. At the bottom, there are "Back" and "Next" buttons. A mouse cursor is pointing at the "Next" button.

Fig. 5.2. Registration: step 2.

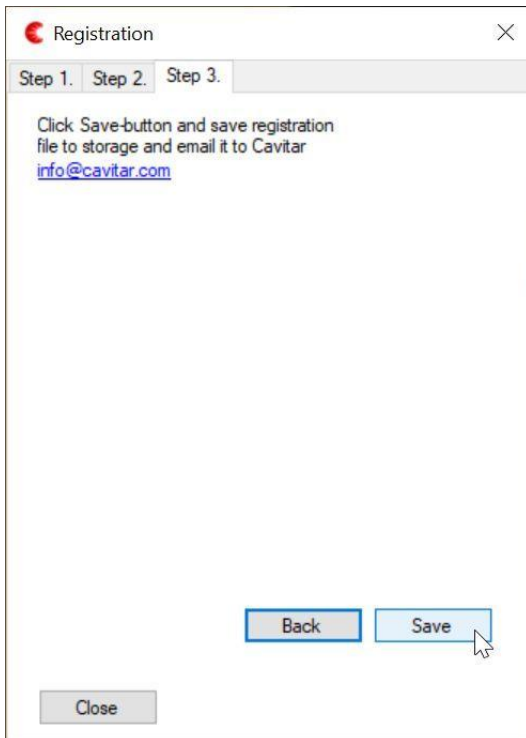

The dialog box is titled "Registration" and has three tabs: "Step 1.", "Step 2.", and "Step 3.". The "Step 3." tab is active. The text reads: "Click Save-button and save registration file to storage and email it to Cavitar" followed by a blue hyperlink [info@cavitar.com](mailto:info@cavitar.com). At the bottom, there are "Back" and "Save" buttons. A mouse cursor is pointing at the "Save" button. A "Close" button is at the very bottom.

Fig. 5.3. Registration: step 3.

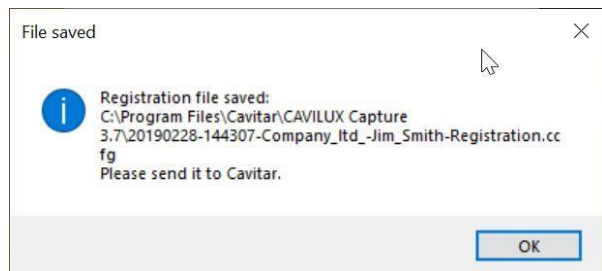

The dialog box is titled "File saved" and contains an information icon (i) on the left. The text reads: "Registration file saved: C:\Program Files\Cavitar\CAVILUX Capture 3.7\20190228-144307-Company\_ltd\_-Jim\_Smith-Registration.cc fg Please send it to Cavitar." At the bottom right, there is an "OK" button.

Fig. 5.4. Registration: file saved notification.



The dialog box is titled "Cavitar Capture registration error" and contains an error icon (X) on the left. The text reads: "Cavitar Capture not registered! Send registration file to Cavitar." At the bottom right, there is an "OK" button.

Fig. 5.5. Registration: final notification.



After receiving the registered file from your vendor or Cavitar, start CAVITAR Capture. The screen shown in Fig. 5.1 will appear. Click “Load” and select the file sent by your vendor or Cavitar. After this a notification appears (see Fig. 5.6) and CAVITAR Capture starts after pressing “OK” (see Fig. 5.7).

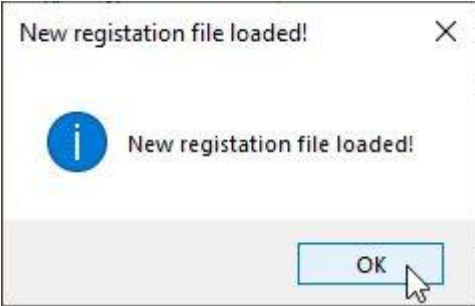

**Fig. 5.6. Registration completed successfully.**

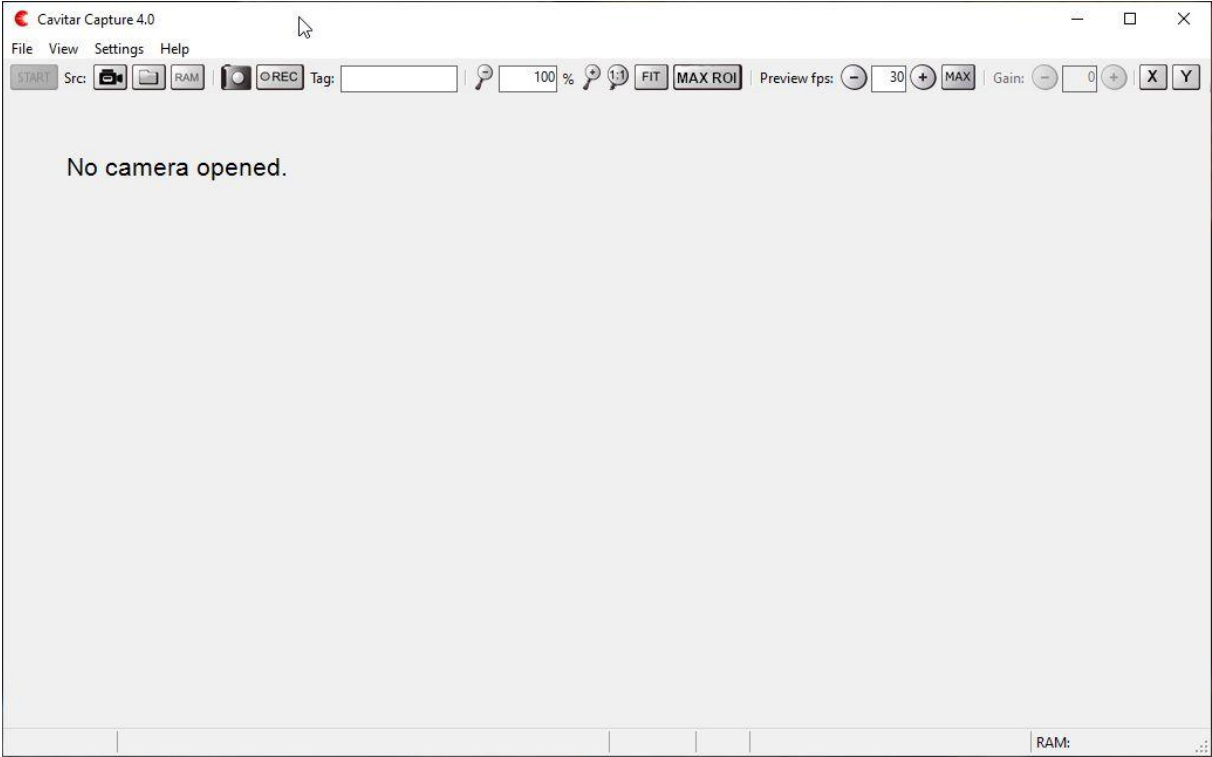

**Fig. 5.7. CAVITAR Capture user interface.**



## 5.2.2 Opening the camera

When CAVITAR Capture starts for the first time, it has to be connected with the camera. This procedure has to be repeated if a different camera is connected to the computer. However, as long as the same (previously selected) camera is connected to the computer, there should be no need to repeat this procedure.

Select “Open Camera...” from “File” menu. This will open the window shown in Fig. 5.8. Select the correct camera and click “OK” (if the camera hasn’t been found by Windows, there will be no camera in the “Select a camera to open” list; in this case wait a while and try again). A view as in Fig. 5.9 will appear.

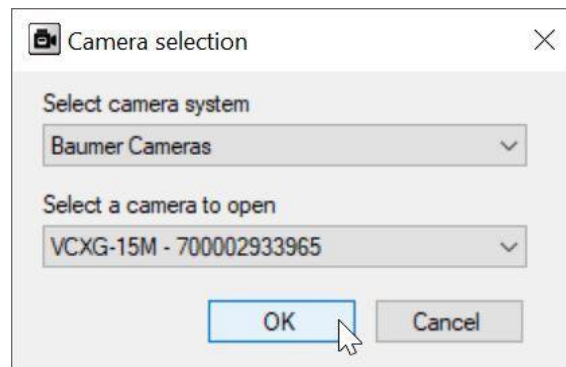

Fig. 5.8. Opening the camera.

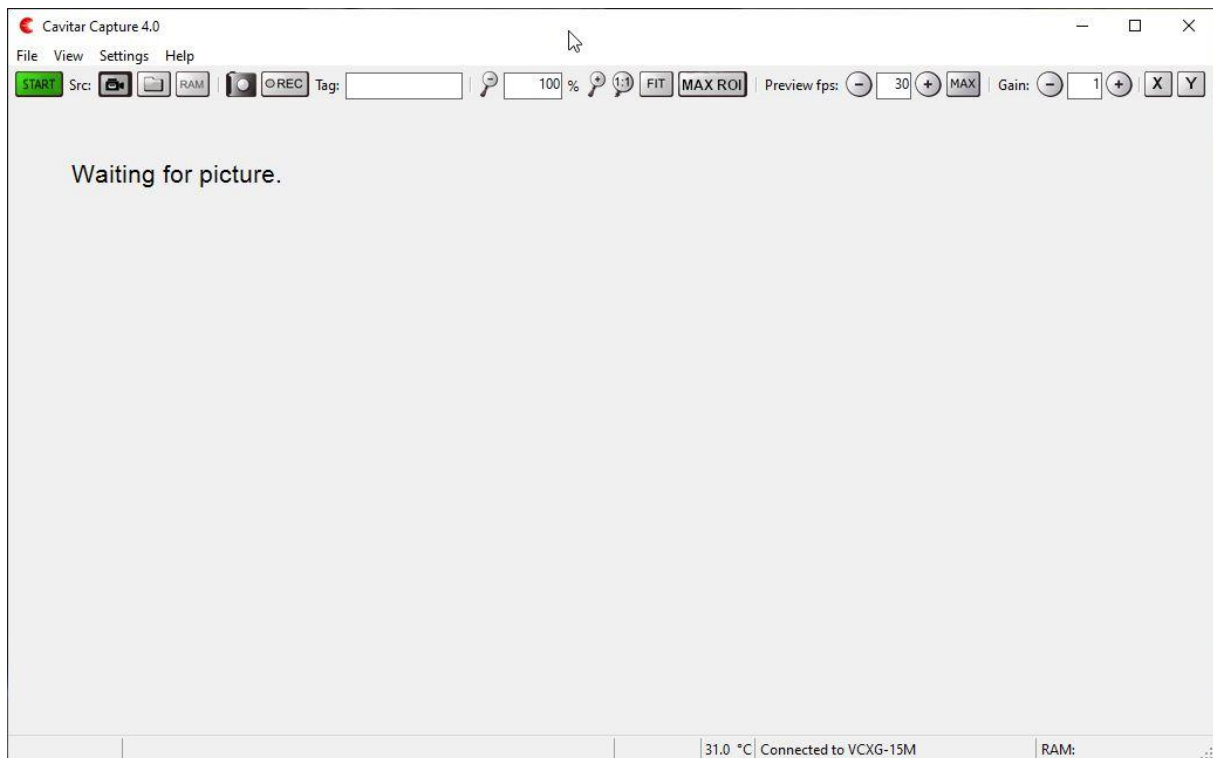

Fig. 5.9. View after camera has been successfully opened.



### 5.2.3 Overview of CAVITAR Capture

The typical graphical user interface (GUI) of CAVITAR Capture is shown in Fig. 5.10 (after Start-button has been pressed). The actual appearance of the GUI as well as the contents of the menu depend on the software version and selected features.



**Fig. 5.10. Overview of CAVITAR Capture.**

In Fig. 5.10:

- A Start/Stop button (for starting and stopping image acquisition)
- B Source buttons (source can be camera, hard disk or RAM)
- C Snapshot button (for single snapshots) and Record button (starts recording according to recording settings)
- D Tag field (text in this field can be added to recording destination folder and file names)
- E Zoom controls (for adjusting the size of the image on screen)  
Note: It is also possible to set desired zoom directly from the GUI in the following way:  
move the mouse cursor to the upper-left corner of the desired area → press and hold down left mouse button → move the mouse cursor to the lower-right corner of the desired area → release left mouse button → press right mouse button and select “Zoom”
- F Preview controls (for adjusting the image refresh rate on screen)
- G Gain control (for adjusting the brightness of the image)
- H Guideline buttons (for adding horizontal and vertical guidelines)
- I Image resolution and bit depth information
- J Cursor location and the grey scale value of the pixel at cursor location
- K Image refresh rate on screen (equals Camera capture rate (Section 5.2.4) if Preview fps  $\geq$  Camera capture rate and equals Preview fps if Preview fps  $\leq$  Camera capture rate)
- L Camera temperature (this value shouldn't exceed 55 °C)
- M Camera connection information
- N RAM usage information



---

The menus contain the following features (available features depend on software version):

File	Open camera... Close camera Open image... Save as... Exit
View	Show toolbar Show zoom tools Show preview fps buttons Show statusbar Show capture frame rate Show recording controls Show sources Show camera capture rate tune controls Show histogram View grid Rotate image by 90 degrees Fullscreen mode (Alt + Enter) <ul style="list-style-type: none"><li>▪ This mode can also be entered/exited by pressing right mouse button</li></ul> Autofit image for fullscreen mode Show zoom controls in fullscreen mode
Settings	Snapshot... Recording... Camera... Image adjustment... Calibration... Guideline and grid properties... External control <ul style="list-style-type: none"><li>▪ See separate guide for detailed instructions</li></ul>
Help	Registration information Language About



## 5.2.4 Camera settings

After a connection to the camera has been established, it is time to adjust camera settings. To do this, select “Camera...” from “Settings” menu. This will open the window shown in Fig. 5.11 (the window shown in Fig. 5.12 can be opened by clicking “Image” tab).

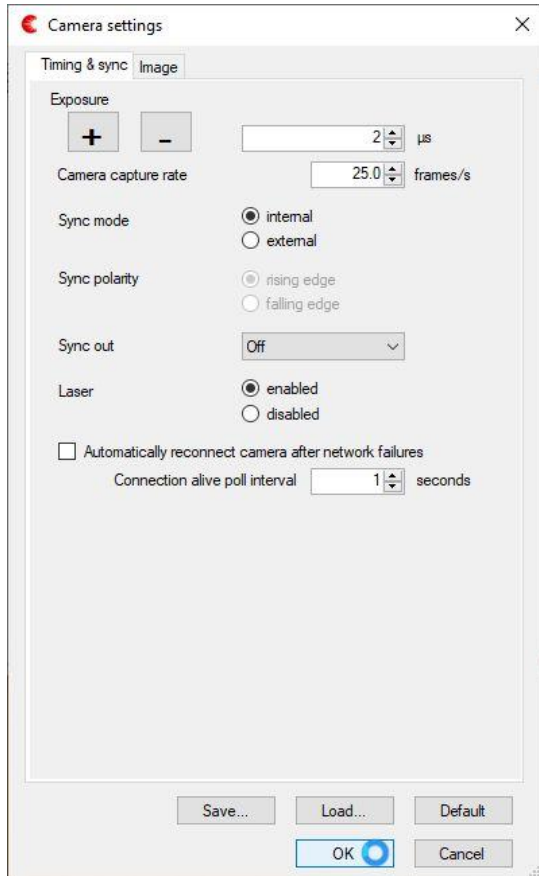

Fig. 5.11. Camera settings (Timing & sync).

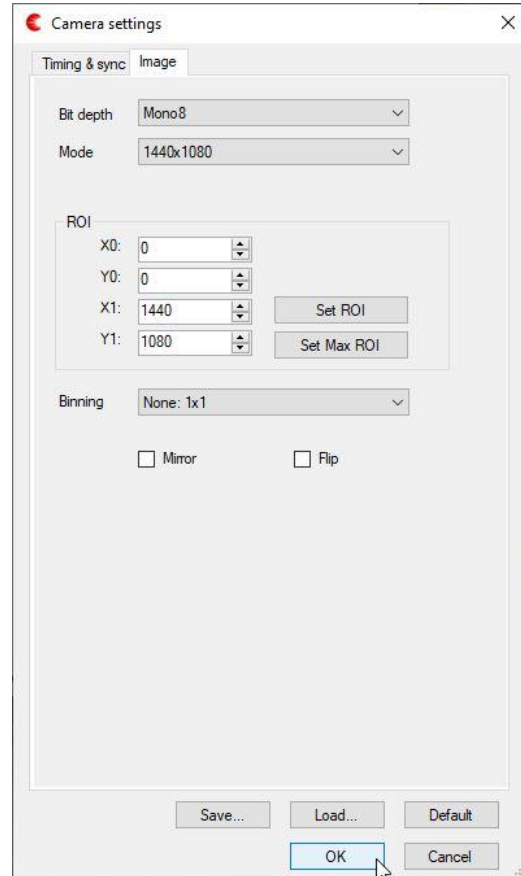

Fig. 5.12. Camera settings (Image).

For optimal results, make the following adjustments on the “Timing & sync” tab:

- set “Exposure” to “2 µs” or “3 µs”, depending on which value gives better results
  - to make the arc brighter, it is possible to increase the exposure time further
- set “Camera capture rate” e.g. to “25 fps” (or your preferred frame rate)
- set “Sync mode” to “internal”
  - the use of external sync mode (e.g. synchronization to arc) requires a special power&sync cable instead of the standard power cable
  - if external sync mode is used, select correct “Sync polarity”
  - external sync signal: 0...4,5V low, 11...24V high, input impedance ~680 ohm
- set “Sync out” to “Off”
  - the use of “Sync out” feature (e.g. to synchronize welding cameras together) requires a special power&sync cable instead of the standard power cable
    - the receiving camera must be set for external sync mode
- set “Laser” to “enabled” in order to have laser illumination in the images
- automatic reconnect feature can be used in case there are connection problems between camera and PC



“Image” tab (Fig. 5.12) contains the following features:

- Bit depth (higher bit depth enables larger dynamic range but increases image file size)
- Mode (different preset resolutions are available)
- ROI (reducing the region-of-interest reduces image file size)
  - It is also possible to set the ROI directly from the GUI in the following way:  
move the mouse cursor to the upper-left corner of the desired ROI → press and hold down left mouse button → move the mouse cursor to the lower-right corner of the desired ROI → release left mouse button → press right mouse button and select “ROI”
- Binning (for reducing image file size and for increasing sensitivity)
- Mirror and Flip: for changing the orientation of the image

## 5.2.5 Image adjustment

Image adjustment tool can be used for optimizing the visual appearance of the image. Image adjustment window can be opened by selecting “Image Adjustment...” from “Settings” menu. This will open the window shown in Fig. 5.13.

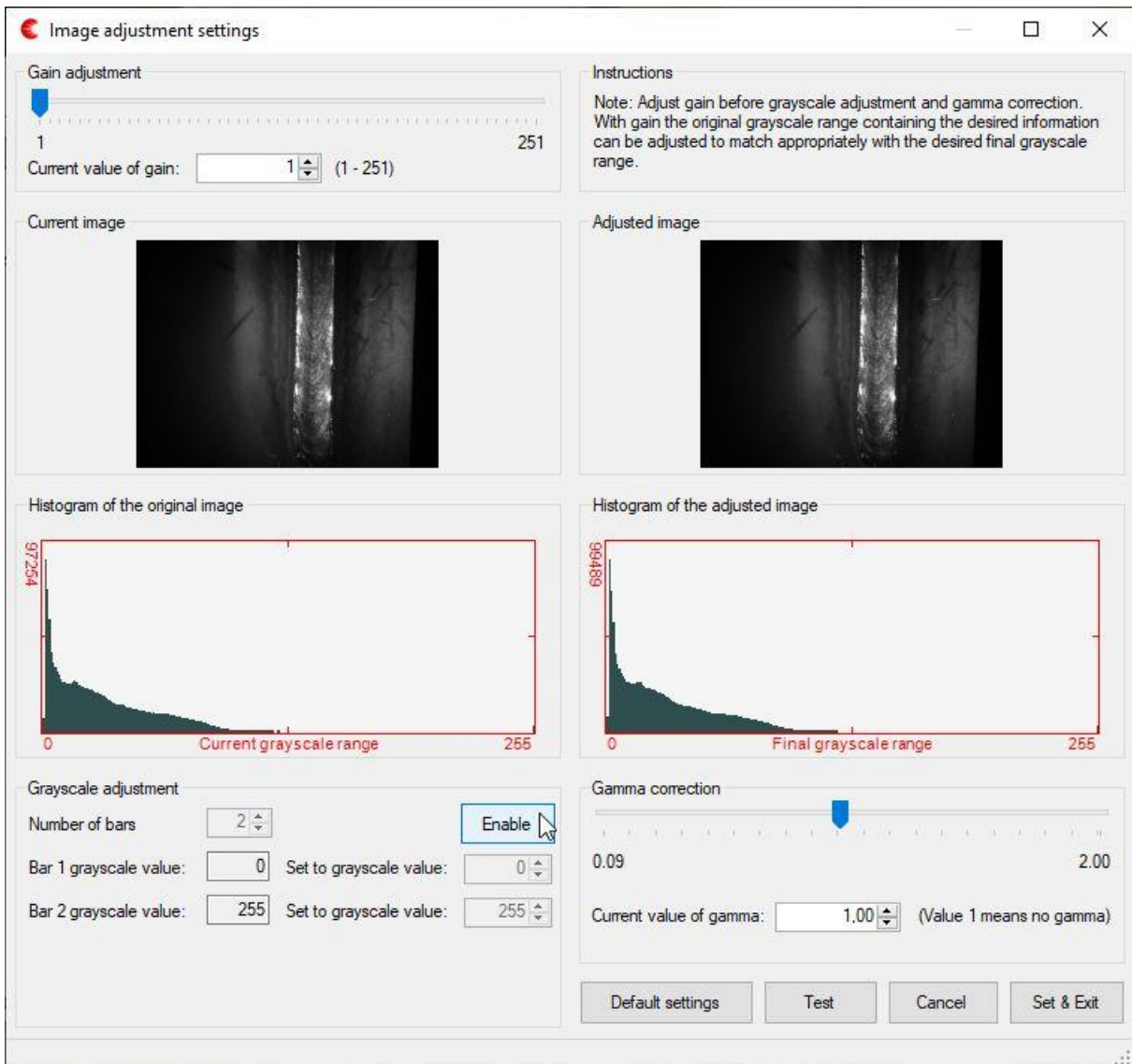
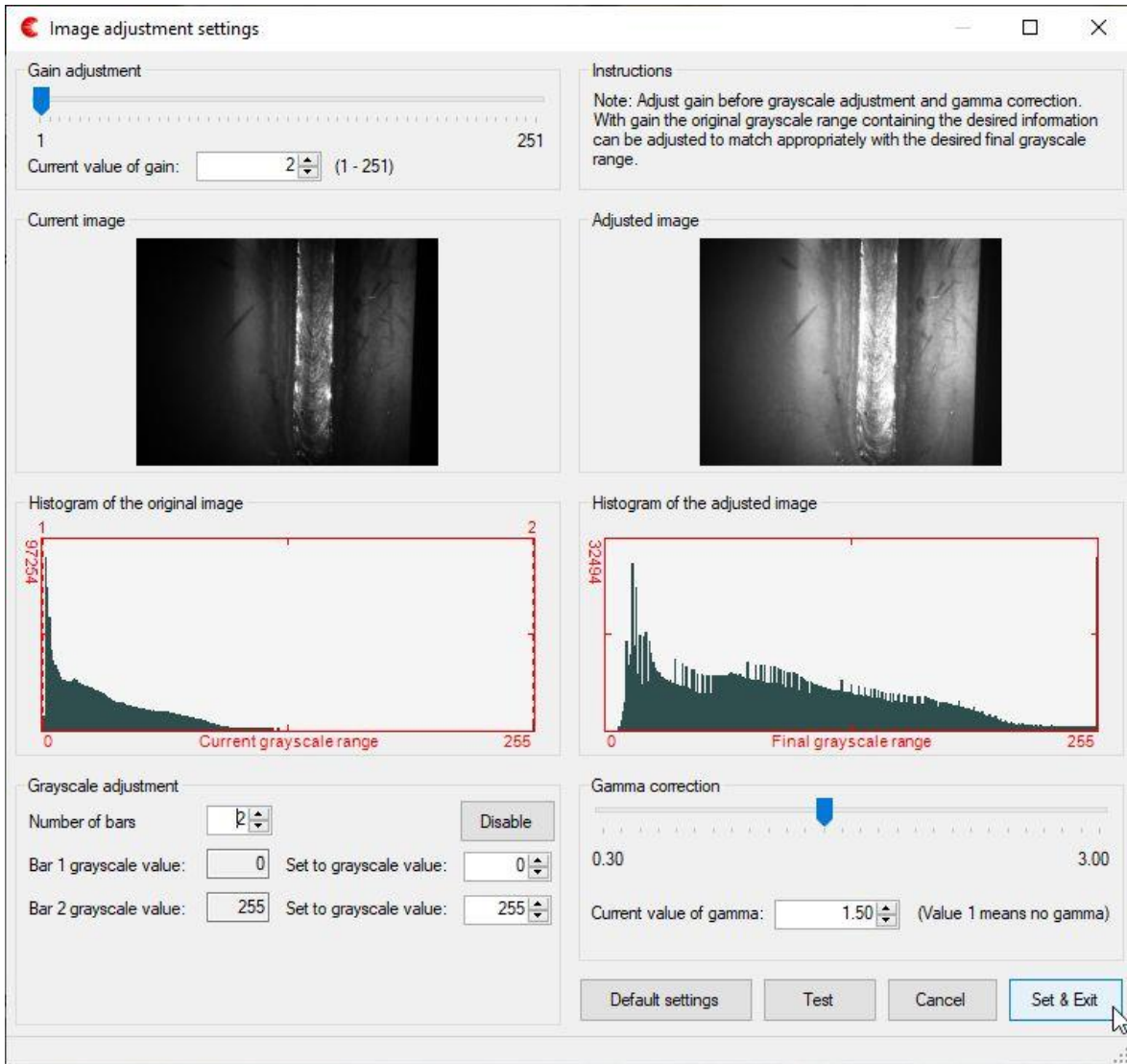

Fig. 5.13. Image adjustment window.



Gain can be applied to make the image brighter. However, large gain values will increase the noise in the images. Gain is typically applied if the original image is too dark (e.g. very dark or highly reflective metal surfaces). Gain can also be adjusted directly from the GUI.

Gamma is a nonlinear correction tool that increases the visibility of dark regions with respect to brighter regions. Gamma correction can often improve the visual appearance of the image. Fig. 5.14 shows the effect of applying gain (1 → 2) and gamma (1.00 → 1.50).



**Fig. 5.14. Effect of applying gain and gamma correction (after pressing “Test” button).**

Grayscale adjustment enables the selection of desired ranges of grayscale values that will be displayed on the screen as different ranges of grayscale values. This can have a big effect on the appearance of the image. As an example, one can assign a larger range for the interesting grayscale value range and a smaller range for the less interesting grayscale value range.

Grayscale adjustment feature is disabled by default since the feature requires the loading of look-up tables whenever software connects with the camera. This loading takes a few seconds and can make the operation of the camera less fluent in certain situations. In order to activate grayscale adjustment feature, press “Enable” button shown in Fig. 5.13.



In Fig. 5.14 two red bars (1 and 2) can be seen in the “Current image” field. Bar 1 is at grayscale value “0” and bar 2 is at grayscale value “255”. These grayscale values are set to “0” and “255”, respectively, in the “Grayscale adjustment” field. Therefore they have no effect. As an example, if one would move bar 2 to grayscale value “100” and keep the “Set to grayscale value” for bar 2 at “255”, the grayscale range from 0...100 of the “Current image” would be spread over the grayscale range 0...255 of the “Adjusted image”.

The number of bars can be also 3 or 4 (determined by selecting the desired value from the “Number of bars” field). By using 3 bars one can e.g. assign the actual grayscale range of 0...50 to be displayed on screen as grayscale range 0...150 and the actual grayscale range of 51...150 to be displayed on screen as grayscale range 151...255. With 4 bars even more detailed adjustment of grayscale ranges is possible. Once the adjusted image looks optimal, the settings can be saved and the window can be closed by pressing “Set & Exit” button.

## 5.2.6 Guidelines

Up to four horizontal and up to four vertical guidelines can be drawn on top of the image. These guidelines can be used for e.g. ensuring that the welding torch follows the correct path. Together with the calibration feature (described in Section 5.2.7 in more detail) guidelines also enable measurements from the images in real time.

In order to add horizontal guidelines, click “X” button (see Fig. 5.10H). Vertical guidelines can be added by clicking the “Y” button, respectively. The guideline options (Move, Lock and Delete; Delete is only available for the latest horizontal and vertical line) can be selected by pressing the left mouse button on top of the guideline. Fig. 5.15 shows the screen with four guidelines.



Fig. 5.15. Guidelines.



Guideline properties can be adjusted by selecting “Guideline and grid properties...” under “Settings” menu. This will open the guideline and grid properties window (Fig. 5.16).

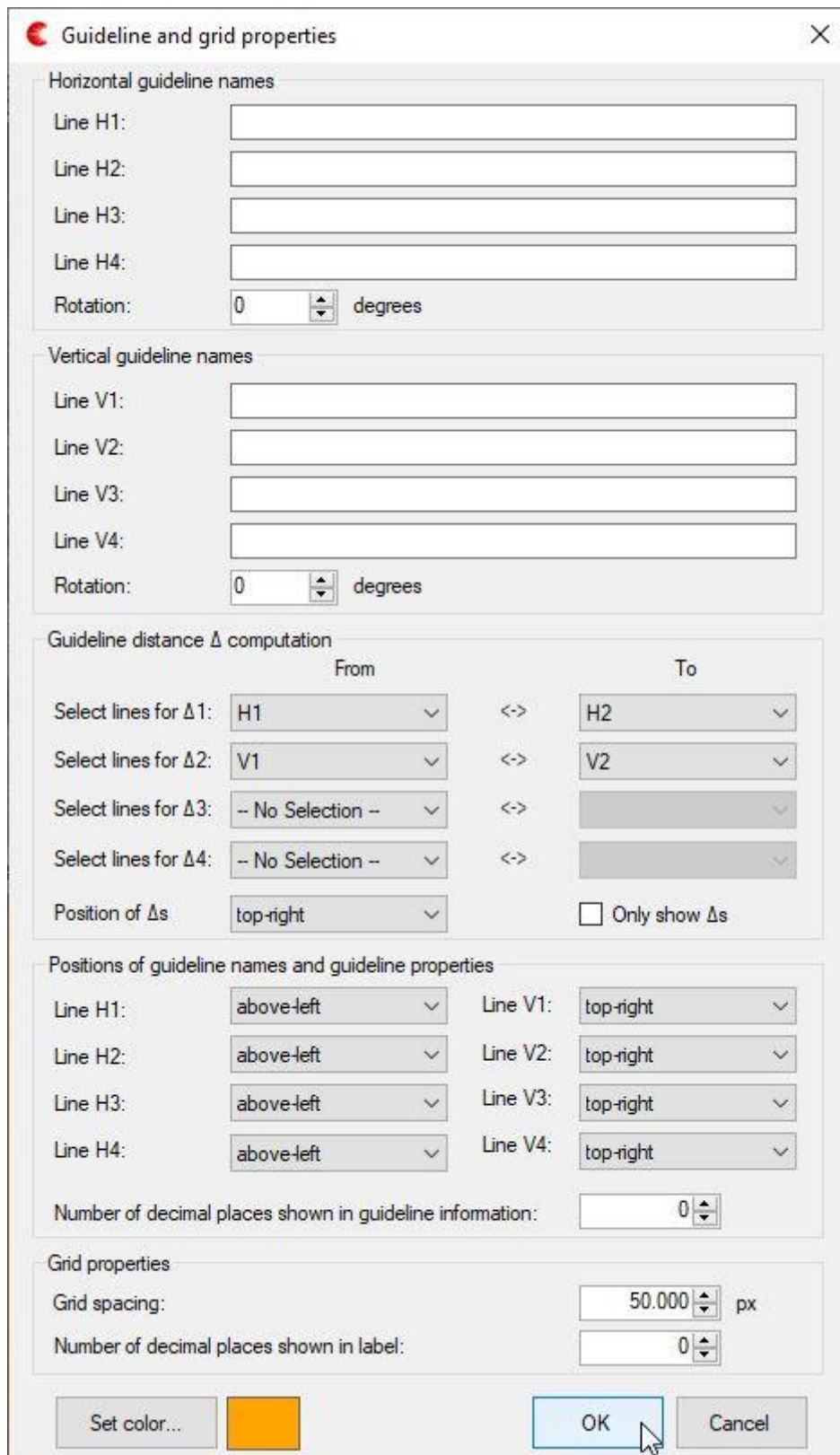

Fig. 5.16. Guideline and grid properties.



Guideline and grid properties window contains the following features:

- Naming and rotation angle for horizontal guidelines
- Naming and rotation angle for vertical guidelines
- Calculation of distances between selected guidelines (up to 4 distances)
- Options for how to display guidelines, guideline names and calculated distances on the screen
- Grid spacing and precision

Fig. 5.17 shows the view after selecting lines for  $\Delta 1$  and  $\Delta 2$  and pressing “OK” in Fig. 5.16.



**Fig. 5.17. Guidelines with calculated distances.**

## 5.2.7 Calibration

Calibration feature enables the calibration of the image so that instead of pixel values it is possible to get actual measures from the images in the desired unit (e.g. mm or inch).

To calibrate the image, select “Calibration...” from “Settings” menu. This will open the Calibration window (see Fig. 5.18).



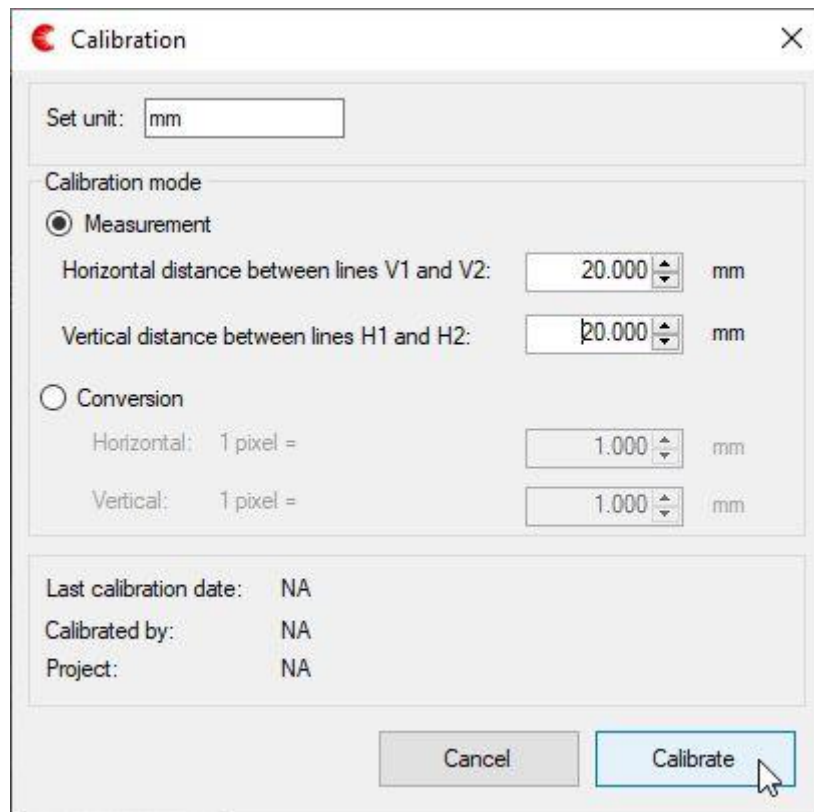

**Fig. 5.18. Calibration mode window.**

In calibration window the desired unit can be set (in Fig. 5.18 “mm” has been set).

Calibration can be made based on measurement (as in Fig. 5.18 above) or as a conversion.

Calibration based on measurement requires that two vertical and two horizontal guidelines have been placed to their correct positions (e.g. according to a precise calibration pattern or some other object with known dimensions). Once the lines are positioned to known distances from each other, these distances can be typed to the appropriate fields.

Calibration based on conversion can be made without guidelines.

In Fig. 5.17 a ruler was applied to position the vertical lines 20mm apart from each other. The distance between horizontal lines was made equal to the distance between vertical lines (in pixels). Therefore a value of 20 mm has been set to both horizontal and vertical distance between lines. After pressing “Calibrate” a new window will appear (see Fig. 5.19).



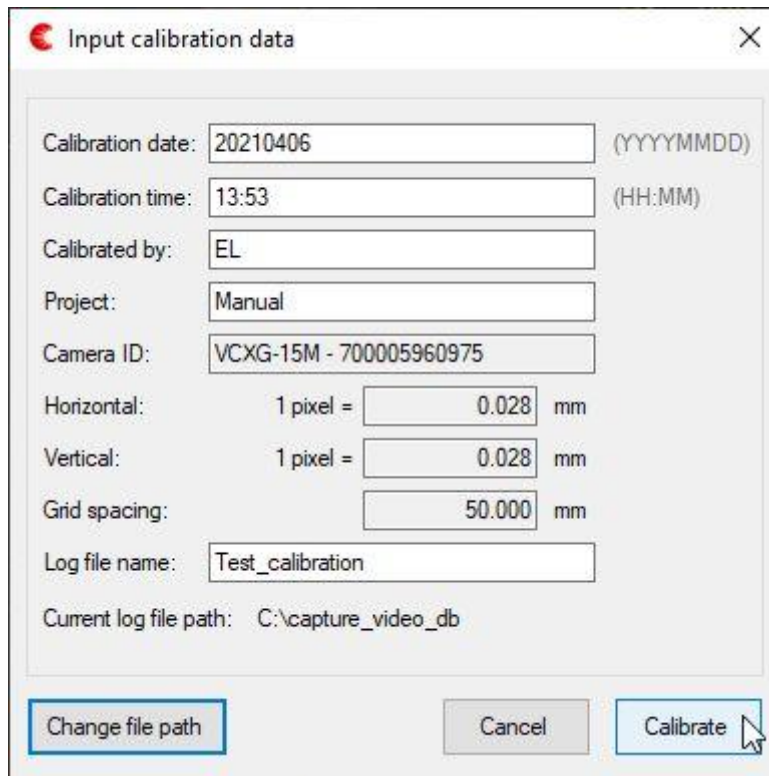

**Fig. 5.19. Calibration data window.**

In order to enable the “Calibrate” button (in Fig. 5.19), all fields in the calibration data window need to be filled. When performing calibration for the first time, also the log file path has to be defined by pressing “Change file path” button. After all information has been successfully filled, the “Calibrate” button becomes active and the calibration can be completed. A confirmation window will appear after pressing “Calibrate” button (Fig. 5.20).

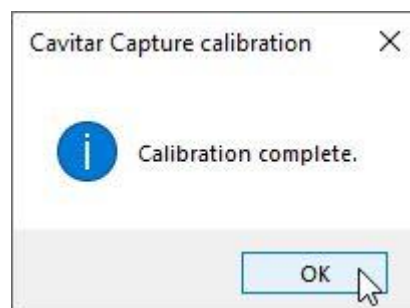

**Fig. 5.20. Calibration complete window.**

Fig 5.21 shows the view after successful calibration. As can be seen, the distances between the vertical and horizontal lines are now in millimetres (instead of pixels as in Fig. 5.17).





**Fig. 5.21. View after calibration.**



## 5.2.8 Recording settings

To define the recording settings, select “Recording...” from “Settings” menu. This will open the window shown in Fig. 5.22. The actual appearance of the window may depend on the software version in use.

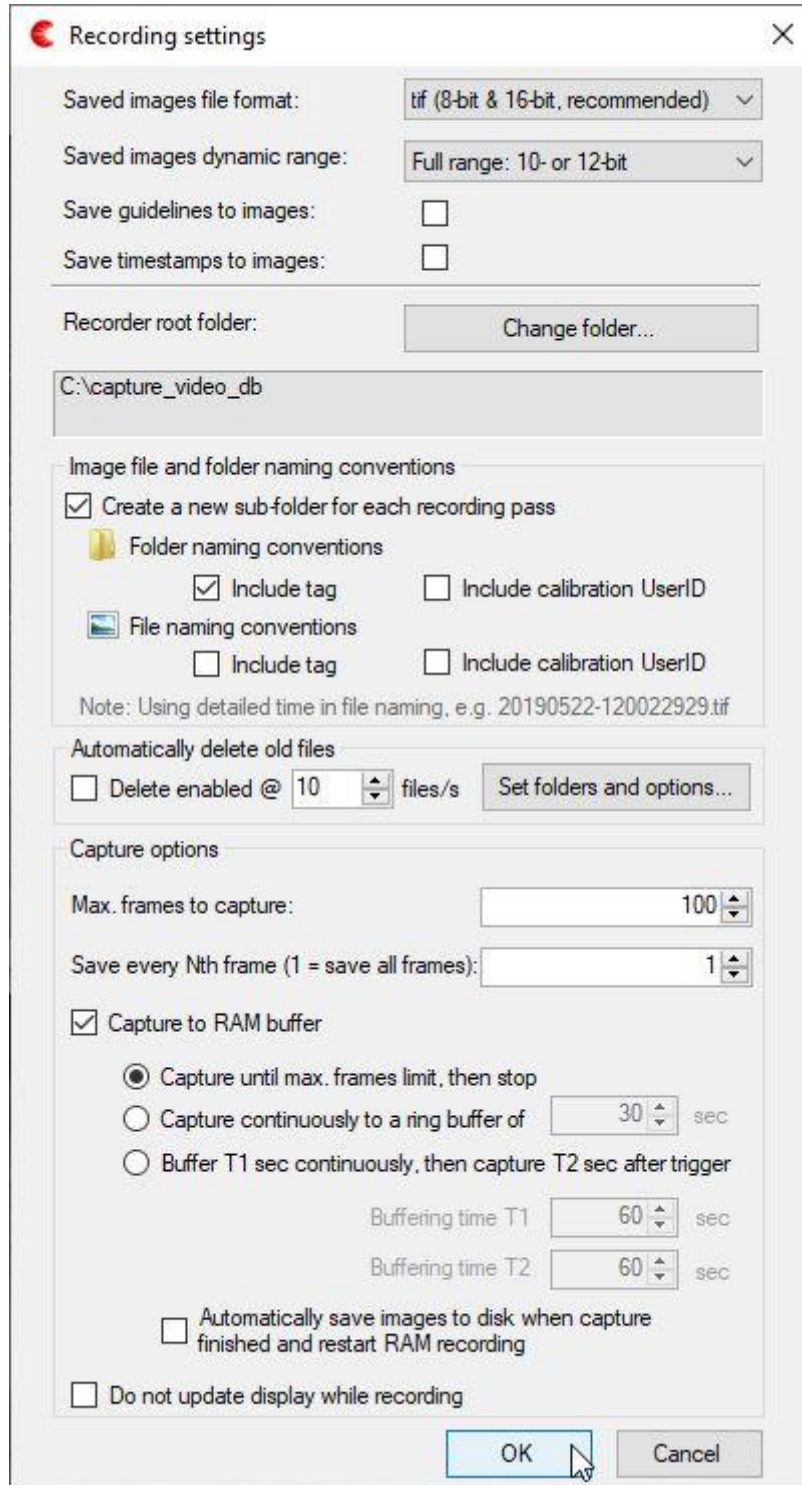

Fig. 5.22. Recording settings.



---

Recording settings contain the following features:

- Saved images file format: available formats include .jpg, .bmp, .tif, .png and .webm
- Saved images dynamic range: available options depend on Camera settings (larger dynamic range increases the size of the saved files)
- Save guidelines to images: guideline information will be “burnt” to the images
- Save timestamps to images: time information will be “burnt” to the images
- Recorder root folder: specify the desired root folder for the recorded images
- Image file and folder naming conventions: select the desired options
- Automatically delete old files: can be used for managing disk space if needed
- Capture options:
  - Max. frames to capture: specify number of frames to capture
    - For unlimited recording, set “Max. frames to capture” to “0”
  - Save every Nth frame (1 = save all frames)
    - This feature can be applied in order to save disk space
  - Capture to RAM buffer (if selected, images will be saved in RAM memory; otherwise images will be saved on hard disk under Recorder root folder)
    - Capture until max. frames limit, then stop
      - This option captures a predefined number of images to RAM and then stops automatically
    - Capture continuously to a ring buffer of ...sec
      - This option continuously captures images to RAM memory and keeps the most recent images within the specified duration in memory, until stopped
    - Buffer T1 sec continuously, then capture T2 sec after trigger
      - This 2-part ring buffer option enables capturing images for a specified duration before and after a dedicated trigger. Trigger can come from operator or from external source (see separate guide for external control for more details)
      - This option also enables automatic save and restart
  - Do not update display while recording: selecting this option frees PC resources if needed

## 5.2.9 Recording images

Recording is started by pressing “REC” button (see Fig. 5.10C). This will start recording according to the recording settings (see Section 5.2.8). If “Max. frames to capture” under recording settings is nonzero, the recording will stop automatically after the specified number of frames has been captured. Otherwise the recording has to be stopped by pressing the “REC” button again or the recording continues until the destination (either hard disk or RAM) is full (except in the case of ring buffer recording).

## 5.2.10 Viewing and saving recorded images

Recorded images can be viewed by selecting the recording destination (either a folder on hard disk or RAM) as source (see Fig. 5.10B). The corresponding screen view is shown in Fig. 5.23 below (in Fig. 5.23 the source is RAM).



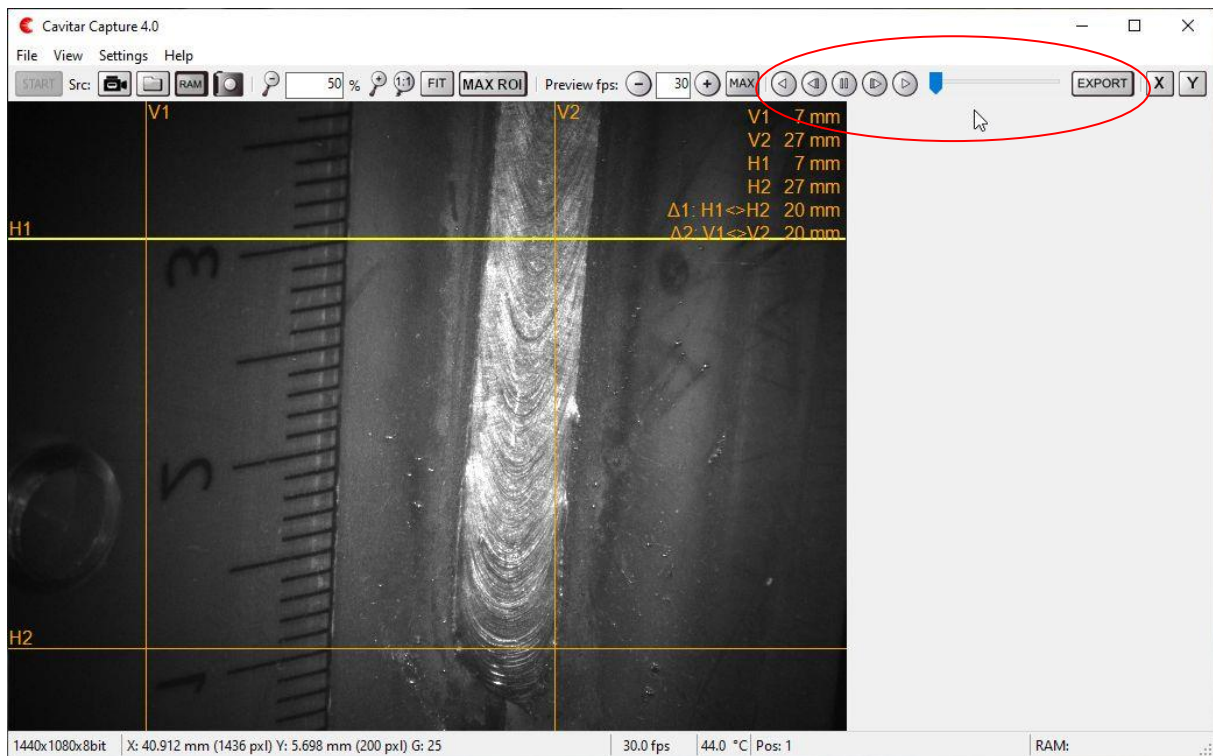

**Fig. 5.23. Viewing recorded images.**

The image player controls for viewing recorded images as well as the “Export” button for saving the images to a desired location have been indicated in Fig. 5.23. It is also possible to move the slider with a mouse. If some or all of the recorded images need to be saved on a hard disk, the “Export” button needs to be pressed. This opens the Export window (Fig. 5.24).

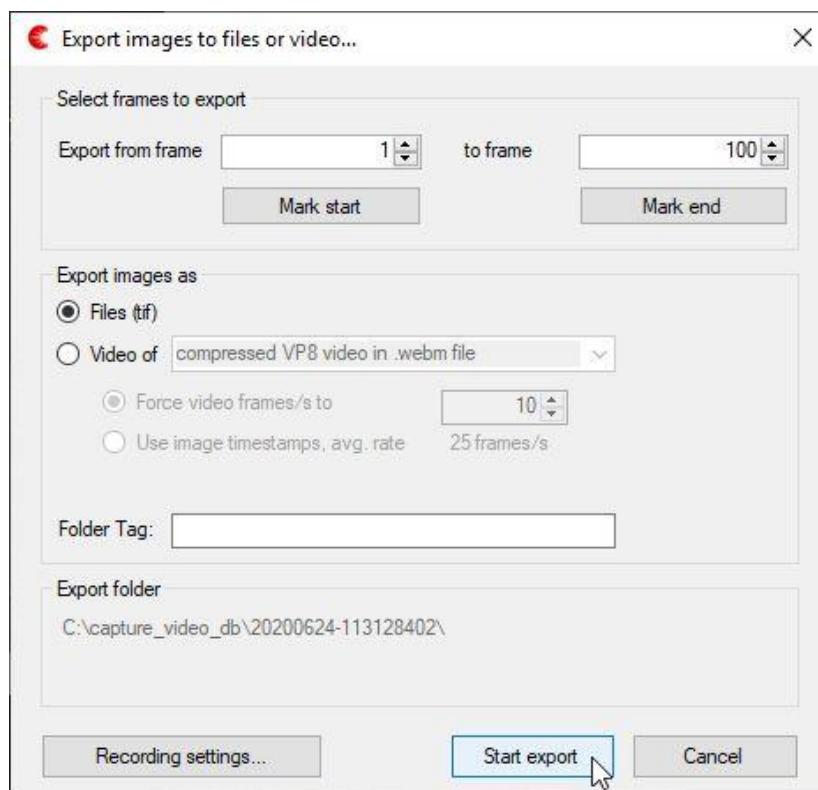

**Fig. 5.24. Export window.**



In the export window it is possible to:

- determine which frames will be saved
  - pressing “Mark start” will set the current image as the first image to be saved
  - pressing “Mark end” will set the current image as the last image to be saved
- choose whether the frames will be saved as separate files or as a video
- add a folder tag, if desirable
- view (and modify, if needed) the recording settings

### 5.2.11 Snapshot

Snapshot means the capture of a single frame. Snapshot can be taken by pressing the “Snapshot” button on the left-hand side of the “REC” button (see Fig. 5.10C). Before taking snapshots it is good to set the snapshot settings by selecting “Snapshot...” from “Settings” menu (see Fig. 5.25).

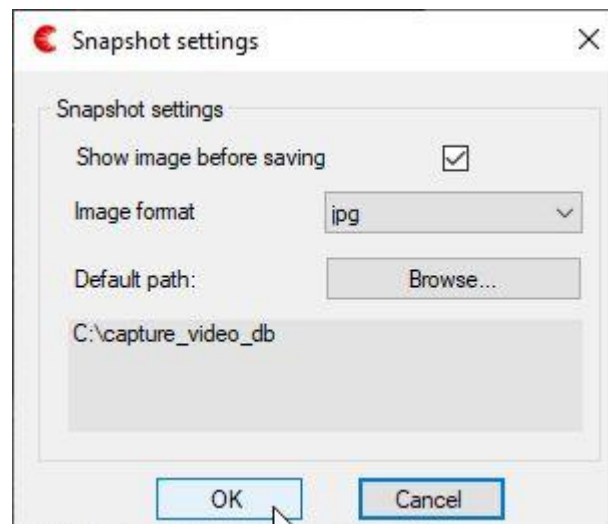

Fig. 5.25. Snapshot settings.

## 5.3 Starting and stopping laser illumination

Laser illumination will start when both conditions below are met:

- “Laser” is “enabled” in Camera settings Timing & sync window (“Settings menu” → “Camera...”)
- “Start” button (Fig. 5.10A) has been pressed

To stop laser illumination (and continue image acquisition):

- Set “Laser” to “disabled” in Camera settings Timing & sync window (“Settings menu” → “Camera...”)

To stop laser illumination (and image acquisition):

- press “Stop” button (Fig 5.10A)
- disconnect the power supply cable from AC mains (this will switch off the entire system)



---

## 5.4 After operation

After operation the following procedure should be carried out:

- ensure that “Stop” button has been pressed (the camera is not taking images)
- exit CAVITAR Capture
- disconnect the power supply cable from AC mains

If the system needs to be completely uninstalled, follow these steps:

- unplug all cables and unmount the camera unit
- carefully pack and store the whole system in a safe and clean place

## 5.5 Troubleshooting

Below are some instructions for solving certain situations if the system doesn't appear to function as expected. If these instructions don't help, please contact your vendor or Cavitar.

### Camera is not found by Windows

- check control, power and GigE cables (cables intact and properly connected)
- check that the system is powered (green led in camera unit is on)
- ensure that e.g. firewall or virus protection software of the computer is not preventing camera connection. It may take some minutes (after powering the system) before the camera is found by the computer. See Section 5.2 for more details

### “No camera opened.” notification in CAVITAR Capture software

- from “File” menu, select “Open camera...” and select the correct camera

### Images are too dark or bright

- check camera settings (“Settings” menu → “Camera...”)
  - for typical settings see Section 5.2.4
- check that image adjustment settings are reasonable
  - for more information see Section 5.2.5
- check that replaceable protective window and the fixed glass window behind it are in acceptable condition (switch off the system before checking the condition in order not to be exposed to laser illumination)
- check that the system is generating laser illumination (pulsed red light). Do not stare directly at the beam!

### Image brightness varies from one image to another (with unchanging target)

- tick “Show camera capture rate tune controls” under “View” menu
  - capture rate tune controls will appear in Capture tool bar
- press + or + button until the image becomes stable
- untick “Show camera capture rate tune controls” under “View” menu

### CAVITAR Capture software image refresh rate is low

- ensure that the “Preview fps” value is sufficiently high (see Fig. 5.10F)
- ensure that the latest network adapter drivers have been installed
- reduce zoom level (e.g. to “Fit” or “1:1”), if possible
- restart the computer



---

## 6 Maintenance and service information

Under normal operating conditions the only regular maintenance task is the replacement of the replaceable protective window of the camera unit. If liquid cooling is applied, cooling liquid needs to be checked and changed regularly and also the cooling channels need to be checked and cleaned up regularly.

### **WARNING!**

Ensure that the power supply is detached from AC mains before performing any maintenance or service operations!

### **Changing the protective window of camera unit**

Sometimes the protective window of camera unit becomes so dirty that it must be replaced. Follow these steps to change the protective window:

- rotate the protective window holder (see Fig. 3.3D) 90 degrees counter-clockwise in such a way that the straight edge is parallel to the bottom side of the protective window. The protective window holder snaps to this position
- remove the protective window (utilize the small slot on the right-hand side of the protective window holder, if needed)
- install a new protective window in place (remove protective foils if applicable, ensure the window is clean and only touch the edges of the window)
- rotate the protective window holder 90 degrees clockwise in such a way that the straight edge is perpendicular to the bottom side of the protective window. The protective window holder snaps to this position

### **Cleaning optical surfaces**

For optimal performance it is important to keep the following optical surfaces clean:

- fixed protective window in the camera unit
- replaceable protective window in the camera unit.

Clean these sensitive optical surfaces primarily by using clean and dry pressurized air. If this is not sufficient, try dry optical wipes. If needed, the optical wipe can be moistened. Do not use strong solvents as they may damage optical surfaces. Be careful not to create any scratches on optical surfaces, as this will deteriorate the performance of the system.

### **Cleaning the system**

Clean casings with slightly moist wipe. Avoid using strong solvents. Ensure the system is fully dry before connecting it to mains supply in order to avoid the risk of electrical shock (pay special attention to connectors).

### **Other maintenance or service needs**

In case any other needs for maintenance or service appear, please contact your vendor or Cavitar (see Chapter 7 for more details).



---

## 7 Support and end of life

### Support and contact information

It is of utmost importance to Cavitar that Welding Camera will work reliably and offers the greatest possible benefit to our customers. These objectives have guided the design and manufacturing of the product. However, if problems occur despite of our efforts, it will be our first priority to solve these problems as quickly and efficiently as possible.

In case of problems please contact your vendor or Cavitar by email or by telephone.

Cavitar Ltd.  
Kuokkamaantie 4 A  
FI-33800 Tampere  
FINLAND  
tel: +358 3 447 9330  
email: support@cavitar.com

Our current contact information is available at our website: [www.cavitar.com](http://www.cavitar.com).

### End of life

It is not allowed to dispose Welding Camera as unsorted municipal waste. The system must be returned to your vendor or to Cavitar for proper disposal at the end of their life. Alternatively one can consult local, state and federal regulations for proper disposal.

Welding camera contains Gallium Arsenide. Gallium Arsenide is toxic and must not be released to the environment.



---

## 8 Limited warranty

Cavitar warrants to the customer, that the product is free from defects in materials and workmanship and that the product is in good working order. Cavitar does not warrant error free or uninterrupted operation of the product.

The warranty is valid only if the serial number plate is on the product (i.e. not removed or defaced).

The warranty for the product is one year starting from the date of purchase or delivery (unless the applicable law establishes a longer period). Cavitar will provide warranty service and technical support free of charge during the warranty period.

In warranty service Cavitar will first diagnose the fault. Cavitar will repair or change the defective product either by delivering a new or refurbished product. Cavitar may give instructions regarding the return or replacement of defective products. Original packing materials should be retained for possible need during warranty period. All exchanged parts and products replaced under warranty period become the property of Cavitar. In the case that the product will be changed, the defective product has to be returned in its original packing materials to Cavitar without delay. Failure to return the defective product will result in an invoice at current or last published list price. A replacement product will be delivered without other parts, cables or options. Those parts need to be removed from the defective product and they have to be used with the replacement product.

Warranty service does not include repair or replacement caused by the following reasons:

- 1) negligence by the user of the product or overloading of the product or failure to observe the operating instructions or proper care,
- 2) transportation of the product,
- 3) unauthorized modifications or attachments have been made to the product,
- 4) the casing of the product has been opened,
- 5) circumstances outside the control of Cavitar such as freezing, fire or accident or it has been misused,
- 6) repairs or maintenance by maintenance people other than those authorized by Cavitar,
- 7) the use of other than original parts provided by Cavitar, and
- 8) normal wear and tear.

The warranty does not cover defects which are insignificant to the use of the product, such as repair of superficial scratches.

The statement of limited warranty is the exclusive warranty. All other expressed or implied warranties including merchantability and applicability for a certain purpose are excluded (except where the applicable law requires said implied warranties). Any warranty, either expressed or implied, will not apply after warranty period.

### LIMITATION OF LIABILITY

To the extent of the applicable law, the sole remedy of the customer is the warranty service set forth above. Cavitar's liability for actual damages of any kind will be limited to the price paid for the product, its repair or replacement. This limitation of liability does not apply to bodily injury or property damage for which Cavitar is held legally liable. In no event will Cavitar be liable for lost profits nor for incidental, consequential or other damages even if advised of the possibility of said damages.

